



APsystems EZ Series (USA) Accessories EN

Rev 1.2

ALTENERGY POWER SYSTEM Inc.
usa.APsystems.com

APsystems America
8627 N. Mopac Expy, Suite 150, Austin, TX 78759
usa.APsystems.com
Mail: info.usa@APsystems.com

© All Rights Reserved

Contents

EZ1-LV Accessories (BC01)	2
1. Wiring Diagram	2
2. EZ1-LV Dimensions	2
3. Accessories Summary	3
4. Physical Picture	3
5. Accessories information	4
EZ1-LV Accessories (Y3)	9
1. Wiring Diagram	9
2. EZ1-LV Dimensions	10
3. Accessories Summary	10
4. Physical Picture	11
5. Accessories information	12

EZ1-LV Accessories (Y3)

1. Wiring Diagram

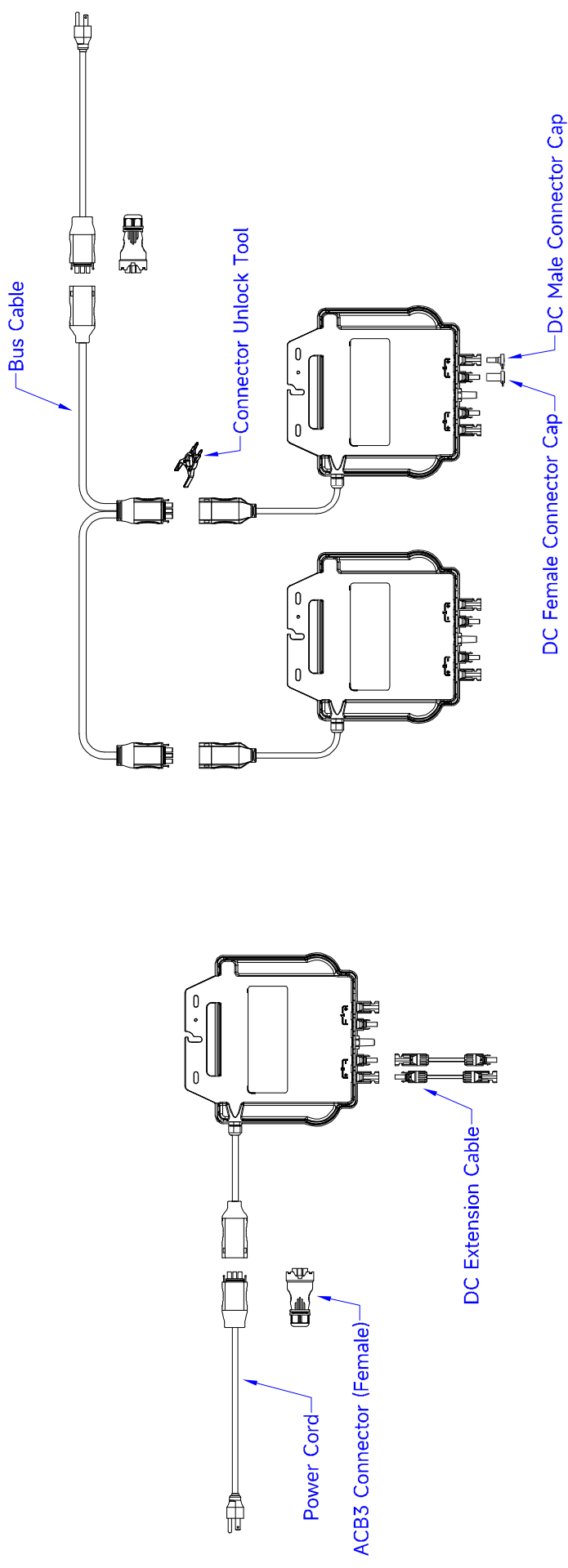

2. EZ1-LV Dimensions

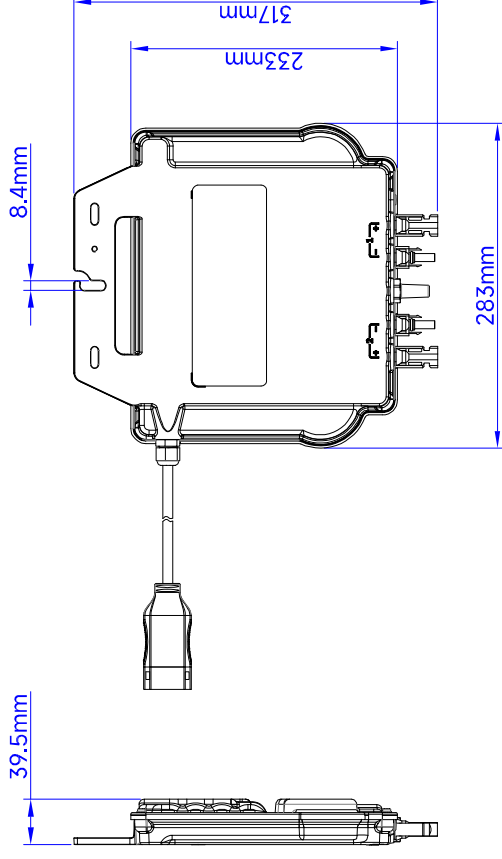





3. Accessories Summary

Region	Accessories						
	Power Cord (Supply)	ACB3 Connector (Female) (Optional)	Bus Cable (Optional)	Connector Unlock Tool (Supply)	DC Male Connector Cap (Optional)	DC Female Connector Cap (Optional)	DC Extension Cable (Optional)
America	US Power Cord (Y3,16AWG,SJ,5m) (See Pic. A)	2301432705_ACB3 Connector(3C,female,25A, two seals) (See Pic. B)	2322971603_Dual Parallel Bus Cable (14AWG,TC,2m) 2322981603_Dual Parallel Bus Cable (14AWG,TC,4m) (See Pic. C)	Y3-DC Connector Unlock Tool (See Pic. D)	2060401006_DC Male Connector Cap (MC4) (See Pic. E)	2060402006_DC Female Connector Cap (MC4) (See Pic. F)	2310360214_2m DC Extension Cable (MC4) (See Pic. G)

Notes: The cables in this table are recommended by APsystems, and the O.D. and length of the cable can be customized according to customer needs

4. Physical Picture

Power Cord	ACB3 Connector(Female)	Bus Cable	Connector Unlock Tool	DC Male Connector Cap
 <p>Pic. A</p>	 <p>Pic. B</p>	 <p>Pic. C</p>	 <p>Pic. D</p>	 <p>Pic. E</p>
 <p>Pic. F</p>	 <p>Pic. G</p>			

5. Accessories information

US Power Cord (Y3,16AWG,SJ,5m)

AWG	CONN	COLOR	Plug
16	L	BLACK	L
	N	WHITE	N
	PE	GREEN	PE

Notes:

- Cable marking: (UL) E356080 SJ 60°C 3×16AWG(1.31mm²) 300V FT1 WUXI ZHONGHUI WIRE & CABLE CO LTD C(UL) TYPE SJ 60°C 3×16AWG (1.31mm²) 300V FT1
- Resistance voltage: AC 2500V, 20mA, 1minute
- Electric testing:
 - Working voltage rating: MAX 125VAC
 - Working current rating: 13A
 - Conductor resistance: 10Ω
 - Resistance voltage: DC 500V
- Others:
 - Blank carton: 25pcs/box, N.W 0.68kg/pcs, G.W 18.6kg/box

CHANGE NO.	CHANGE CONTENTS	REV.	NAME/DATE
①	20pcs/box → 25pcs/box. C/W 15.18kg → 18.6kg	1.1	YCW, 2025-9-1

NO.	NAME	TYPE	MAT.	QTY.	DESCRIPTION	REMARK
3	AC Connector (Female)	AC-3-16A-F		1	16A, IP67	
2	AC Cable	SJ		1	C(UL), 3×16AWG, Black-White-Green	
1	Plug	ZH-Q2		1	13A, 250V~, UL	

TOLERANCES UNLESS OTHERWISE SPECIFIED

> -0.100	±5
> 0.100	±10
> 0.500	±15
> 1.000	±20
> 1.500	±30
> 2.000	±40
> 2.500	±50
> 3.000	±60
> 4.000	±80
> 5.000	±100
> 6.000	±120
> 7.000	±150
> 8.000	±200
> 9.000	±250
> 10.000	±300
> 12.000	±400
> 15.000	±500
> 20.000	±600
> 25.000	±800
> 30.000	±1000
> 40.000	±1200
> 50.000	±1500
> 60.000	±2000
> 80.000	±2500
> 100.000	±3000

UNIT	mm	OF	REV.
SHEET	1	1	1.1

CHK. _____ DRAWING NO. _____

2301432705 ACB3 Connector(3C,female,25A,two seals)



CHANGE NO.	REV.	NAME/DATE

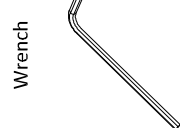
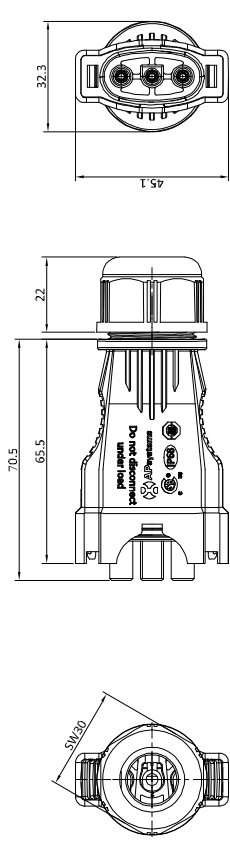

- Notes:
- 1.Rated voltage: 600VAC
 - 2.Max. current: TUV/25A(2.5mm²)
CSA/UL/25A(14AWG)
 - 3.Contact resistance: ≤3mΩ
 - 4.Insulation resistance: ≥500MΩ
 - 5.Ambient Temperature: -40℃~65℃
 - 6.Protection level: IP68 (1m,2H)
 - 7.Mechanical life: ≥100
 - 8.Salt spray test: 24H Neutral salt spr
 - 9.Flame retardant code: UL94-V0
 - 10.UV resistance: I1
 - 11.Adapt cable OD: OD1=7~11.5mm
OD2=10~14.5mm
 - 12.M4 Torque: 1.0N.m
 - 13.M26 Torque: 3.5~3.7N.m(Reference)
 - 14.Type: ACB3-25A-F-AS
 - 15.Use blank cartons for packaging, 150pcs/box, WT 8.79kg/box

NAME	
ACB3 Connector (3C female,25A,two seals)	
DRAWING NO.	
TOLERANCES UNLESS OTHERWISE SPECIFIED	MATERIAL
X: ±0.30	
X: ±0.20	
.X: ±0.10	
DWN.	UNIT mm
CHK.	SHEET OF REV. 1.0

2322981603_Dual Parallel Bus Cable (14AWG,TC,4m)

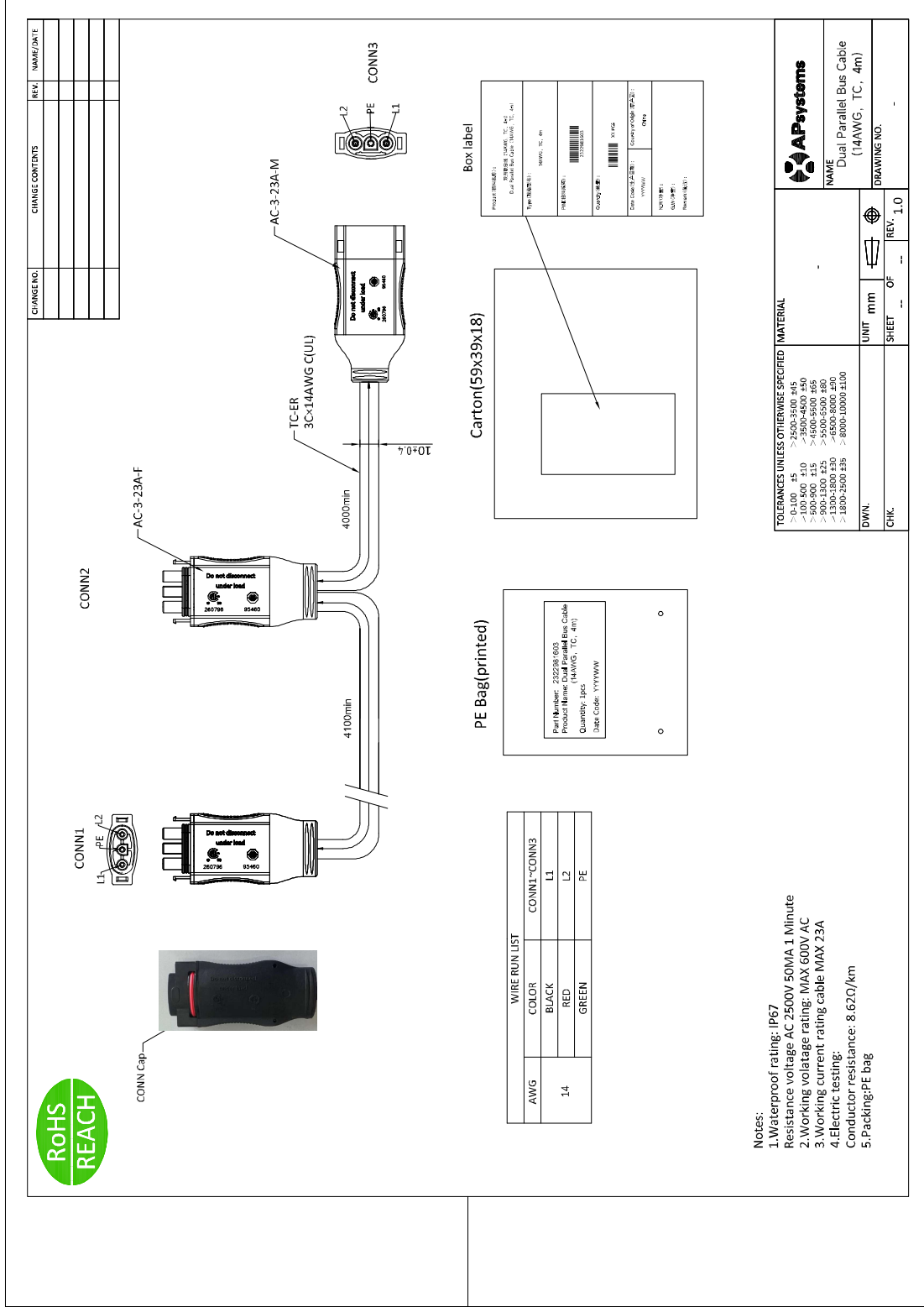



CHANGE NO.	CHANGE CONTENTS	REV.	NAME/DATE
①	Update part name and packaging	1.0	YFT 2025-2-10

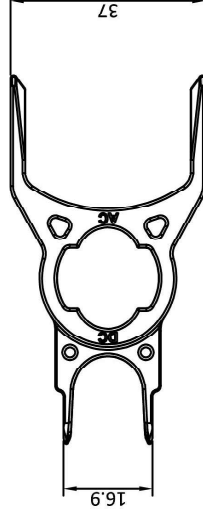
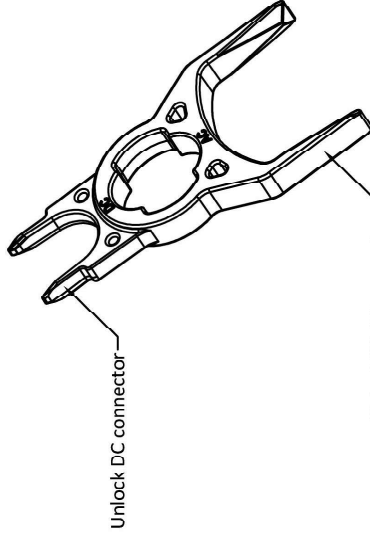
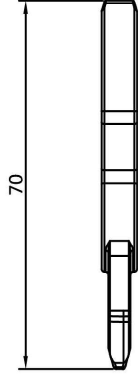

Notes:
 - Color: black

TOLERANCES UNLESS OTHERWISE SPECIFIED MATERIAL

>0.3	+0.20	-0.15
>0.3	+0.20	-0.15
>3-6	+0.24	-0.18
>6-12	+0.24	-0.18
>12-24	+0.32	-0.24
>24-48	+0.38	-0.28
>48-96	+0.44	-0.34
>96-192	+0.50	-0.40
>192-384	+0.56	-0.46
>384-768	+0.62	-0.52
>768-1536	+0.68	-0.58
>1536-3072	+0.74	-0.64
>3072-6144	+0.80	-0.70
>6144-12288	+0.86	-0.76
>12288-24576	+0.92	-0.82
>24576-49152	+0.98	-0.88
>49152-98304	+1.04	-0.94
>98304-196608	+1.10	-1.00

DWN.

CHK.

NAME	Y3-DC Connector Unlock Tool
①	
DRAWING NO.	

UNIT	mm	IN	REV.	1.0
SHEET	OF	--	--	--

Revision history		
Version	Change contents	Date
REV1.0	First edition	2024-07-31
REV1.1	Change Y3 connector unlock tool; Change US Power Cord(Y3); Add ACB3 Connector(Female) for Y3 type; Delete bus cable of EZ1-LV(Y3)	2025-09-18
REV1.2	Update the graphics of EZ1D; Add Dual Parallel Bus Cable of EZ1-LV(Y3)	2025-12-22