

HELIOS ESS INSTALLATION AND OPERATION MANUAL

BATTERY MODEL

52-48-16000 | 900-0077

- INTRODUCTION 4
- 1. AUDIENCE, MESSAGES, WARNINGS, GENERAL SAFETY, PERSONAL PROTECTIVE EQUIPMENT . . . 4
 - 1.1 Audience4
 - 1.2 Warning, Caution, Notice, and Note Messages.....4
 - 1.3 General Warnings5
 - 1.4 Safe Handling Procedures.....6
 - 1.5 Personal Protective Equipment.....7
 - 1.6 Emergency Procedure7
- 2. ITEMS SHIPPED IN THE BOX 7
- 3. SPECIFICATIONS 8
 - 3.1 Electrical Specifications.....8
 - 3.2 Mechanical Specifications.....9
 - 3.3 Environmental Specifications10
 - 3.4 Protection Specifications.....11
 - 3.4.1 Breaker Delay Specifications12
 - 3.5 Internal Heating Specifications13
 - 3.6 Minimum Specifications for Battery Systems.....13
 - 3.7 Regulatory.....14
- 4. TRANSPORTATION 14
- 5. HANDLING 14
- 6. FEATURES 15
 - 6.1 Battery Features15
 - 6.2 Conduit Box (Optional Accessory)16
 - 6.3 Battery Breaker.....16
 - 6.4 Battery ON/OFF Key16
 - 6.4.1 Battery ON/OFF Key LED States17
 - 6.5 LCD DISPLAY.....17
 - 6.6 COM 2 (CAN Port)19
 - 6.6.1 COM2 Port RJ45 Pin Assignment19
 - 6.7 COM3/COM4 (LYNK Port)19
 - 6.7.1 LYNK Port Communication RJ45 Pin Assignment.....20
- 7. THEORY OF OPERATION. 20
 - 7.1 Ingress Protection IP6520
 - 7.2 Internal Heating (HELIOS ESS).....20
 - 7.3 Battery Management System21
 - 7.3.1 Battery Management System Protections.....21
 - 7.3.2 BMS Pre-Charge System22
 - 7.3.3 Battery Management System Load Qualification.....22
 - 7.3.4 Battery Management System Cell Balancing.....22
 - 7.3.5 Battery Charge and Discharge Settings22
 - 7.4 LYNK Network Communication23
 - 7.4.1 LYNK Network Power.....23
 - 7.4.2 LYNK Network Size23
 - 7.4.3 LYNK Network Cables.....23
 - 7.4.4 LYNK Network Termination.....23
- 8. OPTIONAL ACCESSORIES. 24
- 9. INSTALLATION. 24
 - 9.1 Tools.....25
 - 9.2 Location.....25
 - 9.3 Attaching the Battery onto a Wall.....26

9.4	Wiring.....	29
9.4.1	DC Cables.....	29
9.4.2	DC Protection.....	29
9.4.3	Terminal Connections and Hardware.....	30
9.5	Single Battery Installation.....	30
9.5.1	Single Battery Installation Procedure.....	31
9.6	Parallel Battery Installation.....	33
9.6.1	Parallel Battery Installation Procedure (Busbar).....	34
9.7	Grounding.....	36
9.7.1	Grounding the Batteries.....	36
9.8	Closed-Loop Communication.....	37
9.8.1	LYNK Network.....	37
9.8.2	Setting Up Closed-Loop Communication with the LYNK II Gateway.....	38
9.8.3	Setting Up Closed-Loop Communication without the LYNK II Gateway.....	39
10.	OPERATION.....	40
10.1	Low Voltage Cut-Off.....	40
10.2	State of Charge.....	41
10.3	Charging.....	41
10.3.1	Closed-Loop Charging.....	41
10.3.2	When to Charge the Battery.....	41
10.4	Charging Profile.....	43
10.4.1	Bulk Charge.....	43
10.4.2	Absorption Charge.....	44
10.4.3	Equalization Charge.....	44
10.4.4	Float Charge.....	44
11.	ROUTINE INSPECTION.....	44
12.	STORAGE.....	45
13.	BATTERY FIRMWARE AND DATA LOGS.....	46
14.	TROUBLESHOOTING.....	46
15.	RELATED INFORMATION.....	46
16.	GLOSSARY OF TERMS, ABBREVIATIONS, AND ACRONYMS.....	46
	APPENDIX.....	47
A.1	HELIOS ESS Commissioning Checklist.....	47
A.2	HELIOS ESS Decommissioning Checklist.....	49
A.3	HELIOS ESS Closed-Loop Communication - Supported Inverters.....	49
A.3.1	Cables for Closed-Loop Communication Without LYNK II.....	51
A.4	How to Calculate Minimum Battery Sizing.....	53
A.4.1	Calculating the minimum number of batteries per inverter.....	54
A.4.2	Calculating Inverter Peak Current.....	55
A.5	Deye Inverter Configuration (Closed Loop Without LYNK II).....	56
A.5.1	Deye Inverter Configuration (Open Loop).....	59
A.6	Luxpower Inverter Configuration (Closed Loop Without LYNK II).....	62
A.6.1	Luxpower Inverter Configuration (Open Loop).....	65
A.7	Noark Inverter Configuration (Closed Loop Without LYNK II).....	68
A.7.1	NOARK Inverter Configuration (Open Loop).....	71
A.8	Sol-Ark Inverter Configuration (Closed Loop Without LYNK II).....	75
A.8.1	Sol-Ark Inverter Configuration (Open Loop).....	79
A.9	Sunsynk Inverter Configuration (Closed Loop Without LYNK II).....	83
A.9.1	Sunsynk Inverter Configuration (Open Loop).....	85
A.10	Victron Inverter Configuration (Closed Loop Without LYNK II).....	88
A.10.1	Victron Inverter Configuration (Open Loop).....	92

Introduction

The HELIOS ESS, a rechargeable Li-ion battery from Discover Energy Systems (Discover), is a high-capacity, low-voltage battery that can operate independently or in a battery bank configuration where multiple batteries are connected in parallel.

1. AUDIENCE, MESSAGES, WARNINGS, GENERAL SAFETY, PERSONAL PROTECTIVE EQUIPMENT

1.1 Audience

Configuration, installation, service, and operating tasks should only be performed by qualified personnel in consultation with local authorities having jurisdiction and authorized dealers. Qualified personnel should have training, knowledge, and experience in:

- Installing electrical equipment
- Applying applicable installation codes
- Analyzing and reducing hazards involved in performing electrical work
- Installing and configuring batteries
- Installing and configuring systems activated by relays

1.2 Warning, Caution, Notice, and Note Messages

Messages in this manual are formatted according to this structure.



Additional information concerning important procedures and features of the product. Read all the instructions before installation, operation, and maintenance.



Important information regarding hazardous conditions.

⚠ WARNING

Important information regarding hazardous conditions that may result in personal injury or death.

⚠ CAUTION

Important information regarding hazardous conditions that may result in personal injury.

NOTICE

Important information regarding conditions that may damage the equipment but not result in personal injury.

NOTE

Ad hoc information concerning important procedures and features unrelated to personal injury or equipment damage.

1.3 General Warnings



Do not crush, disassemble or dispose of the battery in fire or the garbage.



This product is made of recyclable materials and must be recycled.



⚠ WARNING

ELECTRIC SHOCK AND FIRE HAZARD

- This equipment must only be installed as specified.
- Connect the battery to isolated Power Conversion Systems (PCS) only.
- Do not install the battery in series.
- Do not disassemble or modify the battery.
- If there is damage to the battery case, do not touch exposed contents.
- There are no user-serviceable parts inside.

Failure to follow these instructions may result in death or serious injury.

⚠ WARNING

CHEMICAL HAZARD

Do not touch the exposed contents of a Lithium cell.

Failure to follow these instructions may result in death or serious injury.

⚠ WARNING

ELECTRIC SHOCK AND FIRE HAZARD

Do not lay tools or other metal parts across the terminals.

Failure to follow these instructions may result in death or serious injury.

⚠ CAUTION

HEAVY OBJECT

Two-person or three-person lift is recommended for the battery.

Failure to follow these instructions may result in injury.

CAUTION

ELECTRIC SHOCK HAZARD

- Do not touch the energized surfaces of any electrical component in the battery system.
- Before servicing the battery, follow all procedures to fully de-energize the battery system.
- Follow the [Safe Handling Procedures](#) below when working with the battery.

Failure to follow these instructions may result in injury.

1.4 Safe Handling Procedures

Before using the battery, read all instructions and cautionary markings on the unit and all appropriate sections of this manual.

- Use appropriate personal protective equipment when working with batteries.
- Do not dispose of the battery in a fire.
- Promptly dispose of or recycle used batteries following local regulations.
- Do not disassemble, open, crush, bend, deform, puncture or shred.
- Do not modify, re-manufacture, or attempt to insert foreign objects into the battery, immerse or expose the battery to water or other liquids, fire, explosion, or other hazards. If the user suspects damage to the battery due to water, heat, or other reason, take it to a service center for inspection.
- The battery should only be used for its intended purpose.
- Do not lift or carry the battery while in operation.
- The battery is heavy. When lifting the battery, follow appropriate standards.
- Only lift, move, or mount following local regulations.
- Take care when handling battery terminals and cabling.
- Do not expose the battery to high temperatures.
- Do not submerge the battery.
- Install the battery only in the orientation specified in this manual.
- Only use the battery with a charging system that meets specifications. Using a battery or charger that does not meet specifications may present a risk of fire, explosion, leakage, or other hazards.
- Do not short-circuit a battery or allow metallic conductive objects to contact battery terminals.
- Replace the battery with only another battery that meets the specifications of the system. Using a battery that does not meet specifications may present a risk of fire, explosion, leakage, or other hazards.
- Do not drop the device or battery. If the device or battery is dropped, especially on a hard surface, and the user suspects damage, take it to a service center for inspection.

1.5 Personal Protective Equipment

When handling or working near a battery:

- Use appropriate Personal Protective Equipment, including clothing, glasses, insulated gloves, and boots.
- Do not wear metal rings, watches, bracelets, or necklaces.

1.6 Emergency Procedure

Unusual Odor

- If there is a burning smell
 - Turn OFF the power conversion equipment.
 - Call the installer and schedule an immediate inspection.

Fire

- If there is smoke or other signs of fire:
 - Call 911 (or the emergency phone number in your area).
 - If there is an emergency STOP button, press it to shut down the system.
- Do not attempt to put out the fire.
- Do not spray water or other fire retardants.

2. ITEMS SHIPPED IN THE BOX

Confirm the contents of the box. Discover does its best to maintain quality and accuracy in the shipment of its products. If anything is damaged or missing, please contact customer support immediately.

Table 2-1, HELIOS ESS Box Contents

Items	Description
1	Battery
1	HELIOS ESS Installation and Operation Manual
2	CAT6 cable (1.5 m, 59 inch)
1	Wall-mount bracket
2	Rope handle
1	Termination resistor ^(a)

^(a) The termination resistor was included only in early versions of the HELIOS ESS battery.

3. SPECIFICATIONS

All specifications in this document are published @25°C / 77°F.

3.1 Electrical Specifications

Table 3-1, HELIOS ESS Electrical Specifications

Electrical Specifications	52-48-16000 900-0077
Nominal Voltage	51.2 V
Recommended Voltage Range	48 - 55.2 V
Energy	16,080 Wh
Nominal Capacity	314 Ah
Charge Bulk Voltage - Bulk Vdc	55.2 – 56.8 V
Charge Absorption Voltage - U1 MAX	55.2 – 56.8 V
Charge Float Voltage - U2	53.6 V
Charge Termination Current ^(a)	5 A
Low Voltage Disconnect Recommended	48.0 V
Low Voltage Disconnect ^(b)	43.2 V
Max Continuous Charge Current ^(c)	200 A
Max Continuous Discharge Current ^(c)	200 A
Peak Discharge Current (15 seconds)	300 A RMS
Self Discharge Current (operation)	≤ 25 mA
Self Discharge Current (battery OFF)	≤ 4 mA
Breaker	200 A breaker (CVP-RH-P2BD5-D200-LT)
Maximum short circuit fault current (IBF / ½ IBF)	7.16 kA (100 ms) / 3.58 kA (100 ms)
Arc Flash Incident Energy IEm	0.310 Cal/cm ²
Arc Flash Incident Energy AFB	239 mm (9.41 in)
^(a) Charge termination current is permitted to be less than specified. ^(b) Low Voltage Disconnect is based on 2.7 VPC under load. In no load conditions, do not allow the battery to self-discharge below 3.0 VPC. ^(c) The max continuous charge and discharge currents are the ratings for a full charge and discharge cycle with no rest and without tripping overtemperature protection at 25°C (77°F) ambient.	

NOTE

Reduce the charge termination current to increase the time available for the internal balancing function.

3.2 Mechanical Specifications

Table 3-2, HELIOS ESS Mechanical Specifications

Mechanical Specifications	52-48-16000 900-0077
Chemistry	LiFePO ₄
Height	900 mm (35.43 in)
Width	465 mm (18.31 in)
Depth (body only)	247 mm (9.72 in)
Depth (including Wall-Mount bracket)	271 mm (10.7 in)
Terminal	Quick Connect Plug-and-Pull Terminal
Weight	136 kg (299.83 lb)
Shipping Weight (includes Wall-Mount Bracket, cables, bolts, and rope handles)	150 kg (330.7 lb)
IP Rating	IP65
Case Material	Galvanized Steel Sheet
Color	Pantone Gray 3C

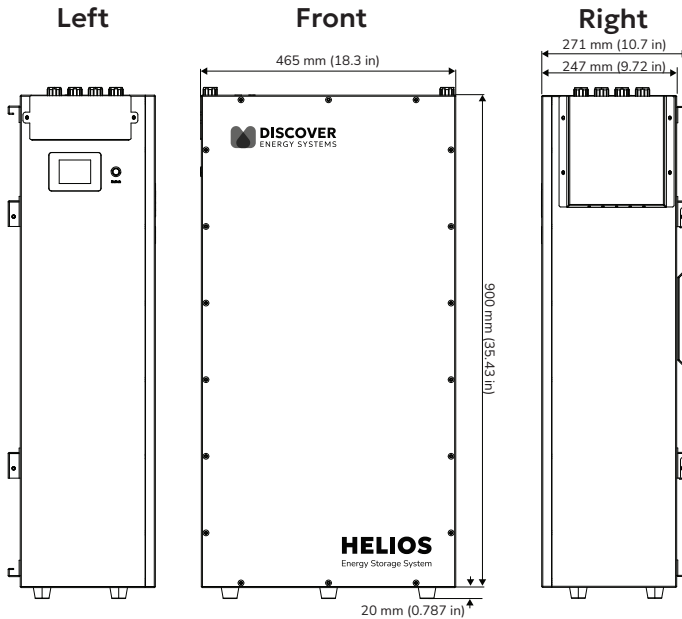

Figure 1. HELIOS ESS Battery Dimensions

Table 3-3, HELIOS ESS Wall-Mount Bracket Specifications

Specifications	Wall-Mount Bracket
Height	497 mm (19.57 in)
Width	363 mm (14.29 in)
Depth	22 mm (0.87 in)
Weight	3.8 kg (8.4 lb)
Material	Galvanized Steel Sheet

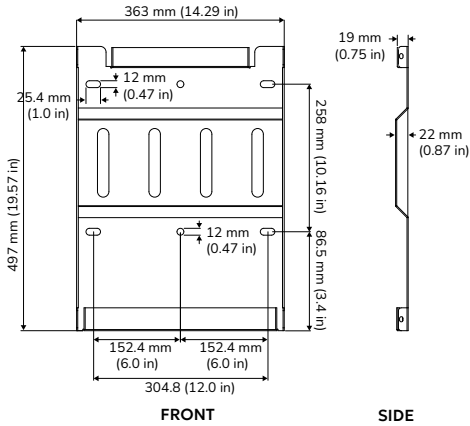

Figure 2. Wall-Mount Bracket Dimensions

3.3 Environmental Specifications

Table 3-4, HELIOS ESS Environmental Specifications

Environmental Specifications	52-48-16000 900-0077
Rated Altitude ^(a)	Altitude of up to 2,000 m (6,561 ft) does not affect operating characteristics
Relative Humidity	5 to 95% (Non-condensing)
Charge Operating Temperature Range ^{(b)(c)}	4°C to 55°C (39.2°F to 131°F)
Discharge Operating Temperature Range ^(b)	-25°C to 55°C (-13°F to 131°F)
Internal Heater Operating Temperature Range ^(d)	-25°C to 8°C (-13°F to 46.4°F)
Storage Temperature (1 month) ^(e)	-20°C to 55°C (-4°F to 131°F)
Storage Temperature (6 months) ^(e)	-10°C to 30°C (14°F to 86°F)

^(a) Consider reducing charge parameters on power conversion equipment at higher altitudes.

^(b) Specifies the temperature of the cells and not the ambient temperature. Ambient temperature and cell temperature may not be the same.

^(c) Although the Battery Management System (BMS) does not allow charging when cells are below 4°C (39.2°F), the battery has a heater that warms the battery to a temperature that enables charging to resume at 4°C (39.2°F).

^(d) When the HELIOS ESS battery cells are between -25°C (-13°F) and 5°C (41°F) and either connected to a charging source or the battery SOC is 50% or more, energy is diverted to the internal heater until the battery reaches 8°C (46.4°F).

^(e) Storage outside of specified temperatures will result in permanent capacity loss and void the warranty.

3.4 Protection Specifications

Table 3-5, HELIOS ESS Protection Specifications

Protection Specifications	52-48-16000 900-0077
Overvoltage	
Protection ^(a)	Above 58.08 V for 3 seconds
Recovery ^(a)	Recovery after 120 seconds and less than 55.2 V
Undervoltage	
Protection ^(b)	Less than 43.2 V for 5 seconds
Recovery ^(b)	No automatic recovery. The battery shuts down after 120 seconds.
Over-Charge Current	
Protection	Greater than 200 A for 10 seconds
Recovery	Remove source. Recovery after 120 seconds
Over-Discharge Current	
Protection ^(c)	Greater than 200 A for 15 seconds
Recovery ^(c)	Remove load. Recovery after 120 seconds
Over-temperature in Charge	
Protection ^(d)	Cell temperature above 55°C (131°F) for 5 seconds
Recovery ^(d)	Cell temperature below 51°C (123.8°F)
Under-temperature in Charge	
Protection ^(d)	Cell temperature below 4°C (39.2°F) for 5 seconds and charge current detected.
Recovery ^(d)	Recovery after 120 seconds and cell temperature 4°C (39.2°F) or higher. Note: Discharge is available to -25°C (-13°F).
Over-temperature in Discharge	
Protection ^(d)	Cell temperature above 55°C (131°F) for 5 seconds
Recovery ^(d)	Cell temperature below 51°C (123.8°F)
Under-temperature in Discharge	
Protection ^(d)	Cell temperature below -25°C (-13°F) for 5 seconds
Recovery ^(d)	Cell temperature above -23°C (-9.4°F)
Load Qualification Protection	
Protection	Mixed System Voltage, Short Circuit, Reverse Polarity, Input Capacitance Overload
Recovery	Re-qualify after 120 seconds. After ten failed attempts to qualify, the battery switches OFF.

Protection Specifications

52-48-16000 | 900-0077

- (a) Overvoltage protection monitors individual cell voltages. Protection is triggered when any cell is over 3.63 VPC and recovers when all cells are below 3.45 VPC for 120 seconds. Voltages are provided for guidance only.
- (b) Undervoltage protection monitors the voltage of individual cells. Protection is triggered, and the battery is set to OFF when any cell is at or below 2.7 VPC. Manually set the battery ON to recover. Voltages are provided for guidance only.
- (c) For time versus current interrupt details, refer to [Figure 3. Over-Discharge Protection Time Curve](#).
- (d) Specifies the temperature of the cells and not the ambient temperature. Ambient temperature and cell temperature may not be the same.

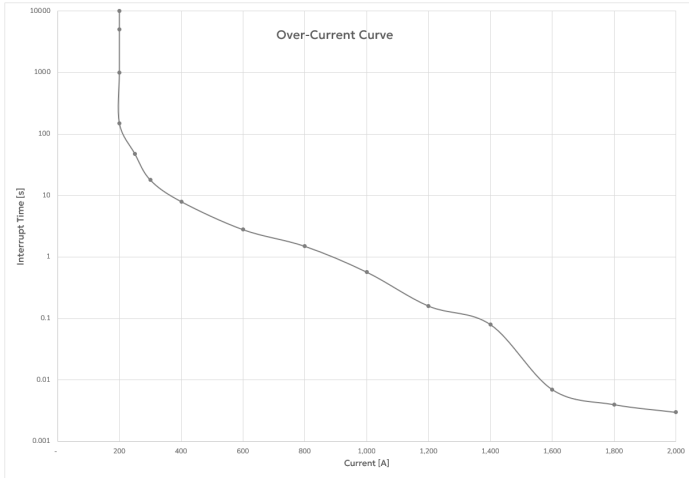

Figure 3. Breaker Protection Time Curve

3.4.1 Breaker Delay Specifications

Table 3-7, Breaker Delay

Rating [%]	Current	Delay Time (seconds) ^(a)
100	200 A	Breaker should not trip
100 - 125	200 - 250 A	Breaker may trip
150	300 A	18
200	400 A	8
300	600 A	2.8
500	1000 A	0.57
800	1600 A	0.007

^(a) The delay time is approximate due to the breaker tolerance range.

3.5 Internal Heating Specifications

Internal heating is available on all HELIOS ESS (52-48-16000, 900-0077) batteries.

Table 3-8, HELIOS ESS Internal Heating Specifications

Internal Heating Specifications	52-48-16000 900-0077
Heating Power	250 W
Heating On ^(a)	<ul style="list-style-type: none">• Below 5°C (41°F), and• Either charge detected or SOC is 50% or more
Heating Off ^(a)	<ul style="list-style-type: none">• Temperature above 8°C (46.4°F), or• No charge current detected and SOC is less than 50%

^(a) Specifies the temperature of the cells, not the ambient temperature. Ambient temperature and cell temperature may not be the same.

3.6 Minimum Specifications for Battery Systems

Install HELIOS ESS batteries in parallel in a battery bank configuration to increase system capacity. Overall battery system capacity must be correctly sized to meet the requirements of the load and account for:

- Total Max Continuous Charge Current
- Total Peak Current
- Total Max Continuous Discharge Current

The total charging capacity of all charging sources in the system should not exceed the Max Continuous Charge Current operating limit of all the batteries in the system. The same is true for discharge. The total discharging capacity of all loads in the system should not exceed the Max Continuous Discharge Current operating limit of all the batteries in the system.

If the Max Continuous Charge Current or Max Continuous Discharge Current is exceeded for any battery in the system, the BMS in that battery will trigger the over-current protection and disconnect. The charging system's maximum charge current must be below the operating limit of installed batteries or be curtailed.

The sum of all the Peak Current values for the attached loads must be less than the Peak Current of the battery system, including inrush current values, for any motors and surge values for any inverters.

For HELIOS ESS batteries installed in parallel in a battery bank configuration, the sum of all battery capacities provides the overall capacity value for the battery system. [Table 3-9, HELIOS ESS DC Capacity Values for Sample Battery Systems](#) provides DC capacity values for sample Discover systems.

NOTICE

- Exceeding the Max Continuous Current of all the batteries in the system will lead to triggering the battery BMS over-temperature protection quicker, resulting in disconnection of all batteries in the system.
- Disconnection will result in a voltage spike (Load Dump), which may damage any component electrically attached to the battery system.

NOTE

The maximum number of batteries installed in a closed-loop configuration with a LYNK Gateway device is 36.

Table 3-9, HELIOS ESS DC Capacity Values for Sample Battery Systems (@25°C, 77°F) (a)

Parallel System	Peak Current	Max Continuous Discharge Current	Max Continuous Charge Current	Usable Capacity
1 battery	300 A	200 A	200 A	16 kWh
2 batteries	600 A	400 A	400 A	32 kWh
3 batteries	900 A	600 A	600 A	48 kWh

^(a) Table 3-9 specifies the upper performance values in a 1 battery, 2 battery, and 3 battery system. To achieve these performance numbers, all the components in your system, including cables and inverters, must be sized appropriately.

3.7 Regulatory

Table 3-10, HELIOS ESS Regulatory

Regulatory
UN38.3 Transportation
UL1973
UL9540A
UL9540 DC ESS 3rd Edition (pending)

4. TRANSPORTATION

Transport it in the original package or equivalent if the battery is not installed in equipment. Per the UN Handbook of Tests and Criteria, batteries are tested to part III, subsection 38.3 (ST/SG/AC.10/11/ Rev. 5). For transportation, the batteries belong to category UN3480, Class 9.

5. HANDLING

Before handling:

- Keep the battery away from sparks and flames
- Disconnect the cables from the battery
- Protect battery terminals from short-circuiting and touch
- Do not lift or carry the battery while it is in use or in operation
- Do not lift the battery by attached battery cables
- Set the battery breaker in the OFF (Open) position

6. FEATURES

6.1 Battery Features

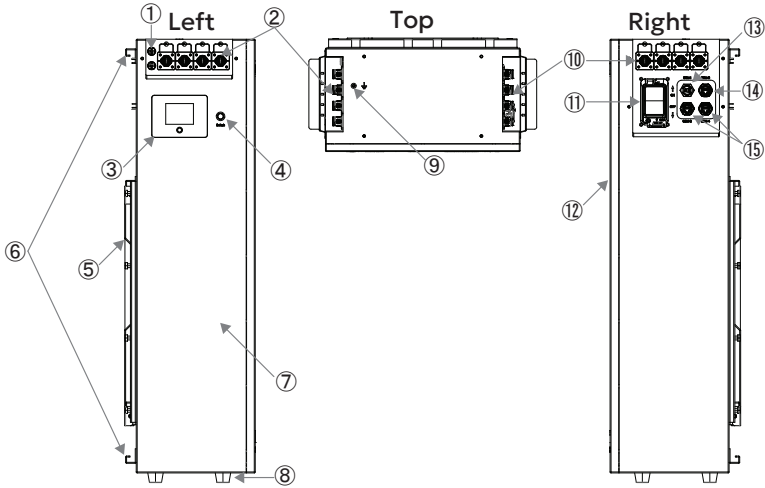

Figure 4. HELIOS ESS Battery Components

Item	Description
1	Breather valves
2	4 x Battery negative terminals (-) black (with quick connects)
3	LCD display (SOC, fault/warning, voltage level, amperes)
4	ON/OFF key
5	Wall-mount bracket
6	Brackets for lifting with rope handles
7	Rubber feet
8	Battery casing
9	Grounding screw
10	4 x Battery positive terminals (+) orange (with quick connects)
11	Single-Pole (positive only) 200 A breaker
12	Front casing cover
13	USB Type-C port for diagnostics and technical support
14	COM2: CAN port for closed-loop communication with supported inverters. For information about the COM2 port and which inverters support direct communication, see A.3 HELIOS ESS Closed-Loop Communication - Supported Inverters .
15	COM3, COM4: 2 x LYNK ports for connecting batteries in parallel

6.2 Conduit Box (Optional Accessory)

Available as an option, conduit boxes provide seamless connections between an inverter and the HELIOS ESS battery.

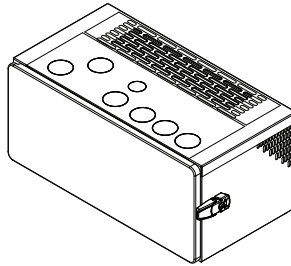

Figure 5. Conduit Box

Table 6-1, Conduit Boxes

Description	Part Number
HELIOS ESS Sol-Ark 15K 2P-N Conduit Box	950-0067

6.3 Battery Breaker

The battery breaker protects the electronic components of the battery's internal BMS from high, externally generated currents.

NOTICE

The breaker and the BMS are independent. Setting the breaker to the ON (Closed) position does not switch the BMS ON. Setting the breaker to the OFF (Open) position does not switch the BMS OFF. Independently set the BMS ON or OFF with the ON/OFF key.

NOTE

Additional external DC fusing or breakers may be required to protect the battery cables from DC overcurrent and to meet installation codes.

6.4 Battery ON/OFF Key

1. To turn ON the battery, first switch the breaker to the ON (closed) position.
2. Briefly press the battery's ON/OFF key to switch the battery ON. The LED lights up orange.
3. To turn OFF the battery, briefly press the ON/OFF key. The LED turns OFF.
4. If desired, switch the breaker to the OFF (open) position.

NOTICE

The breaker and the BMS are independent. Setting the breaker to the ON (Closed) position does not switch the BMS ON. Setting the breaker to the OFF (Open) position does not switch the BMS OFF. Independently set the BMS ON or OFF with the ON/OFF key.

6.4.1 Battery ON/OFF Key LED States

LED	Description
Off	Battery is OFF.
On	Battery is ON.
Pulse	Battery breaker is either open or the battery is warning of an approaching protection limit.
Flash	Battery has faulted. Use LYNK Access software to identify and diagnose the issue.
Double-flash	Battery is identifying itself after the Identify command was issued from LYNK Access software.

6.5 LCD DISPLAY

WARNING
<p>ELECTRIC SHOCK AND FIRE HAZARD</p> <ul style="list-style-type: none"> • Always assume the battery’s main relay is ON (Closed), even if the BDI display shows that it may be off. • Verify the terminal voltage with a voltmeter before handling and installing the battery. <p>Failure to follow these instructions may result in death or serious injury.</p>

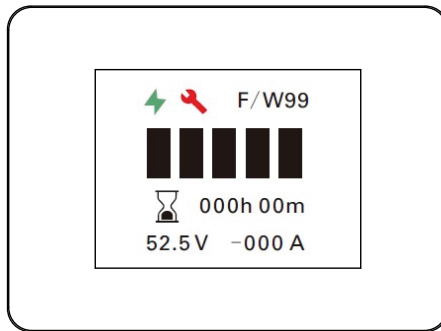





Figure 6. LCD Display

Table 6-2, LCD Display Icons and Values

Icon	State	Description
	Charging	This icon indicates the battery bank is charging and the Remaining Time is an estimate of how much time remains to fully charge all the batteries in the battery bank.
	Fault/ Warning	This icon indicates either a fault or a warning. The "F/W" number identifies the actual fault or warning. For descriptions about each fault or warning, refer to Table 6-3, Fault/Warning Table .

Icon	State	Description
	State of Charge	State of charge of all the batteries in the battery bank. A full charge is indicated when all the bars are displayed.
 000h 00m	Remaining Time	The remaining time is an estimate of how much time remains until: <ul style="list-style-type: none"> • (Charge) All the batteries in the battery bank are fully charged. • (Discharge) All the batteries in the battery bank are fully discharged based on the current load.
52.5 V	Volts	This value identifies the voltage level of all the batteries in the battery bank.
000 A	Amps	This value identifies the total charge or discharge current, in amps, of all the batteries in the battery bank.

NOTE

The LCD Display shows the state of all the batteries in the battery bank. To isolate the values on the LCD Display for a specific battery, disconnect the cables from COM3 and COM4. After confirming the state of the single battery, reconnect the cables to the COM ports to restore closed-loop communication for the entire battery bank.

Table 6-3, Fault/Warning Table

Number	Fault/Warning	Recovery
1	Under voltage	The battery is shut down. Connect the charger and turn ON the battery for it to charge.
2	Over voltage	Decrease charge voltage and automatically recovers after 120 seconds.
3	Under temperature	Connect a charger to turn ON the internal heater.
4	Over temperature	Automatic recovery after the battery cell temperature drops to an acceptable level.
5	Over-discharge current	Disconnect the load. Try again in 120 seconds.
6	Over-charge current	Disconnect the charger. Try again in 120 seconds.
7	Load qualification	The battery failed load qualification at startup. The load qualification could indicate reverse polarity, short circuit, mixed voltage system, or a large capacitive load
8	Breaker	Breaker is open. Turn off the battery and use a DMM to confirm the battery is OFF. Follow all safety precautions as defined in 1.4 Safe Handling Procedures . Confirm why the breaker was switched OFF (open) and resolve the issue. Close the breaker and turn ON the battery.
9	BMS over-temperature	Pause charging for 5 minutes to allow the BMS to cool down. Consider derating the charge current before continuing.

Number	Fault/Warning	Recovery
10	Under-temperature in charge	Leave the charger connected to engage the internal heater. Charging will continue after the battery cell temperature reaches 4°C (39.2°F) or higher.
13	Over-temperature in charge	The battery stops charging and will continue charging only after the battery temperature is below the recovery threshold.

For information on protections, refer to [3.4 Protection Specifications](#).

NOTICE
Damage to the LCD display due to sunlight exposure is not covered by the warranty.

6.6 COM 2 (CAN Port)

The COM2 port on the HELIOS ESS enables closed-loop communication without using the LYNK II Gateway with some brands of inverters (see [Table A-1, Closed-Loop Communication with Inverters](#)). Using the LYNK II Communication Gateway enables communication with all supported inverter brands. The LYNK II Gateway also enables using LYNK ACCESS software for battery diagnostics and connects to LYNK CLOUD for remote battery monitoring.

6.6.1 COM2 Port RJ45 Pin Assignment

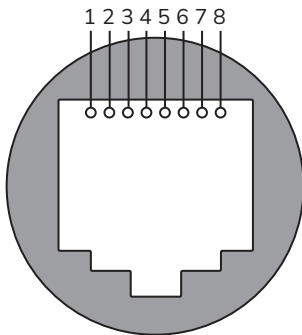

Pin Number	Function
1	(Do not use)
2	(Do not use)
3	(Do not use)
4	CAN High
5	CAN Low
6	CAN Ground
7	(Do not use)
8	(Do not use)

Figure 7. HELIOS ESS COM2 Pins

6.7 COM3/COM4 (LYNK Port)

The COM3 and COM4 ports (LYNK ports) enable multiple Discover batteries to communicate and interact in a closed-loop network. The LYNK ports also enable the HELIOS ESS batteries to work together in a closed-loop communication system with other networked devices, such as inverter-chargers. A closed-loop system enables safety and optimizes system performance.

6.7.1 LYNK Port Communication RJ45 Pin Assignment

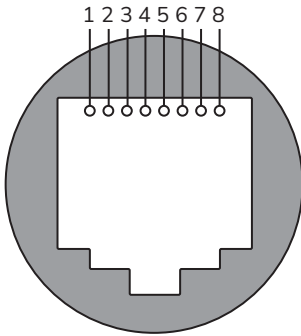

Figure 8. LYNK Port Communication RJ45 pin assignment

Pin Number	Function
1 (1)	Reserved. Do not use.
2 (1)	Reserved. Do not use.
3 (1)	Reserved. Do not use.
4	CAN Low
5	CAN High
6 (1)	Reserved. Do not use.
7	CAN Ground
8	CAN Ground

(1) Do not populate. Do not terminate to power. Do not terminate to ground. Do not terminate to CAN_L or CAN_H.

7. THEORY OF OPERATION

7.1 Ingress Protection IP65

Ingress protection rates the degree of protection provided by mechanical casings and electrical enclosures against intrusion, dust, accidental contact, and water under specified conditions.

The IP65 rating indicates that the product is protected against:

- Dust
- Accidental contact, such as from fingers or tools
- Water, such as low pressure water jets, condensation, and water spray.

NOTE

The battery is not protected against high pressure water jets or submersion in water.

IP codes guide suitability for use under different environmental conditions. IP ratings do not indicate fitness for purpose or confer a performance guarantee.

7.2 Internal Heating (HELIOS ESS)

The HELIOS ESS battery is equipped with internal heating. When the battery's internal temperature is below 5°C (41°F) and the battery is either connected to a charging source or SOC is 50% or more, energy is diverted to the internal heater to avoid the under-temperature fault.

The heating stops when:

1. The battery's internal temperature reaches 8°C (46.4°F).
 - Once the cell temperature reaches this threshold, all the energy is directed to charging the cells.

2. No charge current is detected and SOC is less than 50%.

- After the heating stops, if the battery's internal temperature drops below 5°C (41°F) and the battery is connected to a charging source, the heater turns ON again.

For information about internal heating, refer to [3.4 Protection Specifications](#) and [3.5 Internal Heating Specifications](#).

NOTE

Charging and heating can occur simultaneously. However, the BMS will not allow charging to continue when cell temperature drops below 4°C (39.2°F) for 5 seconds.

7.3 Battery Management System

7.3.1 Battery Management System Protections

The Battery Management System's (BMS) primary function is to monitor cell module voltage, temperature, and battery current. The BMS uses this information to maintain cell operation within operating specifications. If a parameter falls outside of operating specifications, the BMS will disconnect and protect the battery from:

1. **Overvoltage:** Charge voltages that are too high.
2. **Undervoltage:** Discharged voltage that is too low.
3. **Overcurrent:** Current is too high when powering up a load (high inrush current) or from a sustained charging or discharging current above the specified limit.
4. **Over-temperature:** Cell temperature that is too high during charge and discharge.
5. **Under-temperature:** Cell temperature that is too low during charge and discharge.
6. **Load Qualification:** Protection may occur when switching the battery ON. The protection qualifies the load attached to it to prevent switching ON into a reverse polarity, short circuit, mixed voltage system, or large capacitive load.

For trigger and recovery values, refer to [Table 3-5, HELIOS ESS Protection Specifications](#).

The BMS reconnects when it hits recovery thresholds. Manually switch the battery ON if the BMS disconnects due to low voltage protection. If a low-voltage fault is constantly affecting the system, there may be a constant parasitic draw. To prevent the low-voltage fault when the battery is not in use, a physical disconnect switch is recommended.

After a load qualification fault, there is a 120-second delay until you can switch ON the battery again.

NOTE

- Charge and discharge have different operating temperature limits.
- If the BMS disconnects in response to temperature or current limits, the battery automatically restarts only after 120 seconds elapse and the temperature or current reaches normal operating limits.

7.3.2 BMS Pre-Charge System

Turn on all the batteries in the battery bank before energizing any inverter-chargers to prevent tripping a breaker in the battery bank while trying to pre-charge the system.

The battery has a Pre-Charge System to energize external capacitive loads before switching the main relay ON. The maximum input capacitance for a single battery should not exceed the values in [Table 3-1, HELIOS ESS Electrical Specifications](#).

NOTICE

When switching ON batteries, the inrush current may cause the batteries to fault as they energize external capacitive loads. If the battery fails to turn ON, it retries up to 10 times. Verify the cables and connections, then switch ON the batteries again.

7.3.3 Battery Management System Load Qualification

When the battery switches from the OFF state to the ON state, the battery BMS will qualify the external load before switching ON the main relay. Load qualification will reject switching ON into short circuit, reverse polarity, mixed voltage systems, or capacitive loads that exceed the batteries limits.

The battery will attempt Load Qualification a maximum of ten times. After ten failed attempts at Load Qualification, the battery switches OFF.

During Load Qualification, or when a load is disqualified, the ON/OFF key flashes and displays fault code 7 on the LCD display (see [Table 6-3, Fault/Warning Table](#)).

7.3.4 Battery Management System Cell Balancing

The cell balancing circuits in the battery compare all cells in a battery and balance the cell voltage at the end of the charge. When there is a network of batteries over the LYNK port, all battery cells are balanced as an entire system, not as individual batteries.

7.3.5 Battery Charge and Discharge Settings

The HELIOS ESS supports direct closed-loop communication with some brands of power conversion devices. Other types of inverters, such as Schneider XW+ and XW Pro with Xanbus, require a LYNK Communication Gateway. In addition to communication, the LYNK II provides other benefits such as monitoring, diagnostics, programmable relays, and LYNK CLOUD. For further information, please refer to the LYNK II Gateway Communication User Manual available from the discoverenergysys.com website, or contact your Discover provider for assistance.

Refer to the appropriate LYNK II Communication Gateway Application Note available from discoverenergysys.com for the set up of closed-loop parameters and integration with specific brands of solar inverter-chargers and solar charger controllers.

7.4 LYNK Network Communication

Discover batteries use CAN communication over the LYNK Network to coordinate performance with other batteries and communicate with accessories such as the LYNK II Communication Gateway.

7.4.1 LYNK Network Power

A Discover battery provides the LYNK network power through the LYNK port (COM3/COM4 on the HELIOS ESS). Discover documentation specifies how many batteries are required to provide sufficient power for the LYNK network and compatible accessories. Some accessories may require more than one battery to provide sufficient power.

NOTICE

Do not use an external power source to power devices over the LYNK Network.

NOTE

The LYNK II Communication Gateway is required for diagnosis of the batteries and to use the LYNK Cloud web service.

7.4.2 LYNK Network Size

One LYNK Network can support up to 36 HELIOS ESS Batteries. The total length of the LYNK network cables must not exceed 36 m (118 ft).

7.4.3 LYNK Network Cables

CAT6 or higher cables (included with HELIOS ESS batteries) network HELIOS ESS batteries.

7.4.4 LYNK Network Termination

When not using the LYNK II Gateway with early versions of HELIOS ESS batteries that were supplied with a termination resistor, LYNK network termination is required on the last battery in the LYNK network.

8. OPTIONAL ACCESSORIES

The following optional accessories are available for the HELIOS ESS battery.

Table 8-1, HELIOS ESS Accessories

Accessory	Part Number
LYNK II Communication Gateway	950-0025
HELIOS ESS Sol-Ark 15K Conduit Box	950-0067
HELIOS ESS Battery to Inverter Power Cables	
<ul style="list-style-type: none"> • 2 pairs of 200 A cables with lug and quick connect: <ul style="list-style-type: none"> • 2/0 AWG Positive Power Cable (1.0 m, 39.37 inch) • 2/0 AWG Negative Power Cable (1.0 m, 39.37 inch) 	950-0070
<ul style="list-style-type: none"> • 2 pairs of 150 A cables with lug and quick connect: <ul style="list-style-type: none"> • 1/0 AWG Positive Power Cable (1.0 m, 39.37 inch) • 1/0 AWG Negative Power Cable (1.0 m, 39.37 inch) 	950-0071
HELIOS ESS Parallel Wire Kit (battery to battery)	950-0068
<ul style="list-style-type: none"> • 1 pair of 200 A cables with quick connects: <ul style="list-style-type: none"> • 2/0 AWG Positive Battery Cable (1.35 m, 53 in) • 2/0 AWG Negative Battery Cable (1.35 m, 53 inch) • CAT6 Cable (1.35 m, 53 inch) (COM3/COM4) 	
HELIOS ESS Terminal Connector Set	950-0072
HELIOS ESS Battery Lifting Handles	950-0069

9. INSTALLATION

The following instructions describe how to connect single or multiple batteries in parallel to an inverter.

WARNING

ELECTRIC SHOCK AND FIRE HAZARD

- This equipment must only be installed as specified.
- Do not disassemble or modify the battery.
- Do not touch exposed contents if the battery case has been damaged.
- There are no user-serviceable parts inside.

Failure to follow these instructions may result in death or serious injury.

NOTICE

- Some chargers and inverters support temperature-compensated charging. Disable temperature-compensated charging on the charger or inverter.
- Do not use or install a battery temperature sensor.

NOTE

It is the responsibility of the installer to ensure that all applicable installation requirements and standards are met.

9.1 Tools

- Insulated tools sized to match nuts, bolts, and cables
- True RMS Voltmeter
- Wall stud finder
- Appropriate personal protective equipment

9.2 Location

The HELIOS ESS battery can be installed indoors or outdoors.

Install the battery in locations that meet the following requirements:

1. **Wall mount.** The battery is designed to be wall mounted. Secure the batteries so that at least 4 bolts of the Wall-Mount Bracket are supported by wall studs.
2. **Spacing.** If installing one or more batteries, allow spacing of at least 25.4 mm (1 in) to the sides. More spacing may be required to access the various ports and terminals and to view the LCD on the side of the battery.

Use the HELIOS ESS Terminal Connector Set (950-0072) to create your own cables and adjust the spacing between batteries as required by the system.

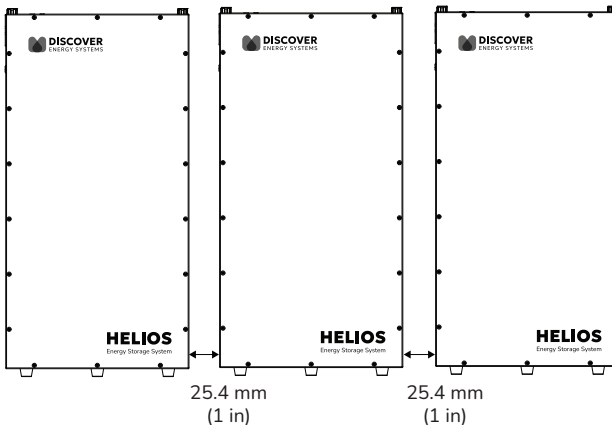

Figure 9. Battery spacing

3. **Do not install in direct sunlight.** Avoid installing the battery in an area with high ambient temperature.

NOTICE

Damage to the LCD display due to sunlight exposure is not covered by the warranty.

4. **Moderate temperature.** The ambient temperature should be between 4°C and 40°C (39.2°F and 104°F). Ambient temperatures of 15°C to 20°C (59°F to 68°F) are ideal for extending battery life.
5. **Ventilation.** If housing the batteries in a room, add vents to allow airflow to the outdoors.
6. **Away from water.** Do not install in locations that are susceptible to flood or water leakage. If flooding is a danger, install above the ground.
The rubber feet provide the battery with 20 mm (0.787 in) of clearance above the ground. Check with local requirements on whether the installation requires extra space below the battery.
7. **Orientation.** Installing the battery with its feet pointed towards the ground is the recommended orientation. **Never install the battery upside down (feet pointing up).** If you install the battery using any other orientation, ensure the battery is securely mounted and supported to prevent movement and stress on the connections.

NOTE

- Do not use the battery in a location with excessive vibrations.
- The battery has not been evaluated for seismic environments.
- Using this product in a location that does not meet requirements will void the warranty.
- Using this product in any orientation except the recommended orientation may affect performance and the warranty. If you use an alternative orientation, regularly monitor the battery to check for abnormalities.

9.3 Attaching the Battery onto a Wall

⚠ CAUTION

HEAVY OBJECT

Two-person or three-person lift is recommended for the battery.

Failure to follow these instructions may result in injury.

The following instructions are based on installing the battery onto a wall. Instructions on installing the inverter itself are provided in the inverter manufacturer's documentation.

1. Use a stud finder to locate the wall studs.
Identify a location that optimizes usability and support for the inverter and battery.
The battery's Wall-Mount Bracket requires at least 4 bolts supported by wall studs.
2. Attach the rope handles to the battery and using a two/three-person lift, move the battery to the installation location.

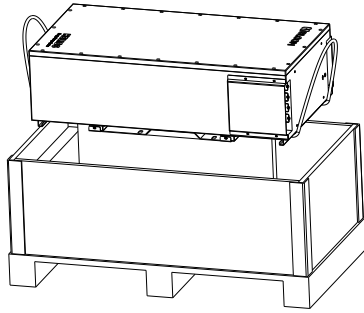

Figure 10. Use rope handles to lift battery

The Wall-Mount Bracket is attached to the back of the battery.

3. Remove the screws affixing the Wall-Mount Bracket to the battery. Put the screws aside in a safe location.
4. If installing the battery off the ground and if the wall studs are not in ideal locations, consider adding appropriate structural supports to spread the weight of the 136 kg (299.83 lb) battery.
5. Use the dimensions in the following diagram to mark the location of holes for the HELIOS ESS battery Wall-Mount Bracket. Verify the holes are level and at the right height.

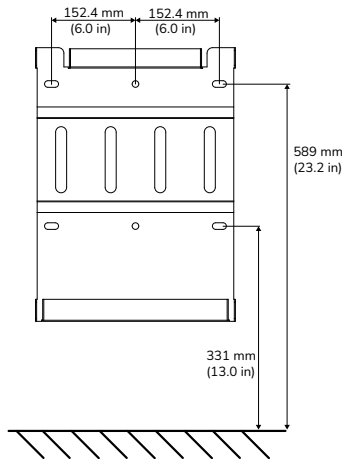

Figure 11. Wall-Mount Bracket Drill Holes

6. Drill the holes for the Wall-Mount Bracket.
7. Secure the Wall-Mount Bracket to the wall using appropriate fasteners that can support the battery's weight and are compatible with the material of the wall or studs.
8. Attach the HELIOS ESS battery to the Wall-Mount Bracket.
 - a. Using a two/three person lift, lift the battery with the battery lifting handles (950-0069), hydraulic lift, or other industrial equipment and hook it onto the Wall-Mount Bracket.

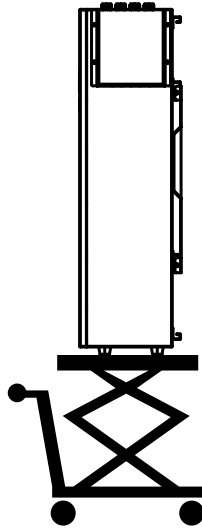

Figure 12. Hydraulic Lift to Mount Battery onto Wall-Mount Bracket

- b. From the right and left sides, secure the battery to the Wall-Mount Bracket with the screws that you put aside in step [3](#).

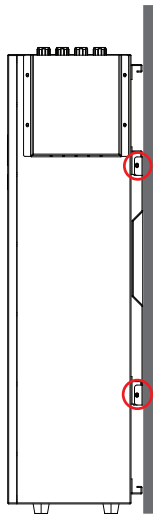

Figure 13. Secure Battery to Wall-Mount Adapter

9. Install the inverter near the battery. Refer to the inverter manual for instructions.
10. Next, wire the batteries and the inverter.

NOTE

The cover plate protecting the battery terminals and COM ports is installed inside out for shipping purposes. Please keep this in mind when re-attaching the cover plate after wiring the battery and communication cables.

9.4 Wiring

9.4.1 DC Cables

CAUTION

FIRE HAZARD

Undersized cables can become hot and may potentially catch fire.

Failure to follow these instructions may result in injury.

To create your own cables, use 2/0 AWG (70 mm²) or 1/0 AWG (55 mm²) cables. Attach appropriately sized ring terminals on one end and a HELIOS ESS Terminal Connector (950-0072) on the opposite end. Choose the cables and ring terminals to accommodate the maximum voltage of any circuits sharing the same wiring space. Ensure they are sized to local codes and meet the following requirements.

1. **Copper-stranded cable.** DC cables must be stranded, copper, and rated 90 °C minimum. Terminate the cables on one side with lugs that fit the DC terminals on the inverter, and use the quick connect on the other side of the cable for the positive or negative battery terminal.
2. **Minimum and equal cable lengths.** Select a location that minimizes the length of battery cables to reduce voltage drop from the impedance leading to reduced performance. If installing multiple batteries in parallel, the length of all the battery cables should be the same.
3. **Appropriate cable gauge.** The cables should be capable of carrying the normally expected current, plus a margin of safety.
4. **Proper polarity.** Positive (+) is connected to positive (+), and negative (-) is connected to negative (-). Verify the polarity of all connections before energizing batteries.

NOTE

For instructions on connecting terminal connectors to cables, refer to the [HELIOS ESS Battery Cable Terminal Connector Set Manual](#) (805-0099).

9.4.2 DC Protection

CAUTION

FIRE HAZARD

- Undersized fuses and disconnects may become overloaded and potentially cause a fire.
- Fuses and disconnects are required to open before the cable reaches its maximum current carrying capability.

Failure to follow these instructions may result in injury.

Each battery comes equipped with a 200 A integrated breaker. When multiple batteries are installed in parallel, additional DC overcurrent protection is recommended between the battery bank and inverter-charger.

1. **Appropriate size.** Size the fuses and disconnects following local codes to protect the wiring in the system. The fuses and disconnects are required to open before the cable reaches its maximum current carrying capability.
2. **Install protection.** The fuse and disconnect should be located close to the battery. Local codes may limit how far the protection can be from the battery.

NOTE

- AC circuit breakers and DC circuit breakers are not interchangeable. Check the label on the circuit breaker to ensure it is the correct type and rating. Use only DC circuit breakers.
- The local electrical code in your area may require disconnect switches either in the positive only, or both positive and negative. Refer to your applicable code and check with the authority having jurisdiction to confirm local requirements.

9.4.3 Terminal Connections and Hardware

Plug-and-pull quick connects are used to mate with the plug-and-pull terminals on the HELIOS ESS battery.

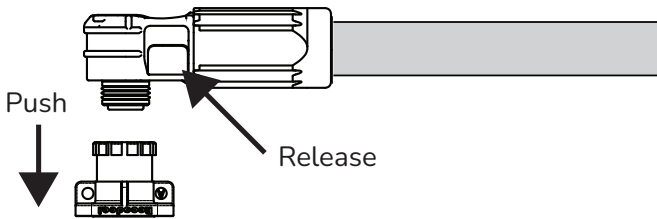

Figure 14. Plug-and-Pull Quick Connect

1. Plug the connector into the plug-and-pull terminal.
2. Gently pull the connector to confirm it is snapped in place.
3. To disconnect, press the release button on the side of the connector.

9.5 Single Battery Installation

Install equipment following the standards set by the local authority having jurisdiction.

⚠ CAUTION

FIRE HAZARD

Use cables that meet specifications. Undersized cables can become hot and potentially catch fire.

Failure to follow these instructions may result in injury.

To optimize performance, battery cables (battery to load and battery to charger) must meet the following requirements:

1. **Minimum cable length.** Select a location that minimizes the length of battery cables to reduce the voltage drop.
2. **Equal cable gauge.** The battery cables should be the same gauge.
3. **Equal cable length.** The battery cables should be of equal length.

9.5.1 Single Battery Installation Procedure

⚠ CAUTION

ELECTRIC SHOCK AND FIRE HAZARD

- Take precautions to avoid bridging the terminals.
- Do not contact the terminals with metal mountings, fixtures, or body parts.

Failure to follow these instructions may result in injury.

Install equipment following the standards set by the local authority having jurisdiction. The following instructions assume the battery and inverter have been attached to the wall.

1. Prepare the inverter and battery for wiring.
 - a. If the inverter is wired to a power source, open the disconnect and set the inverter OFF.
 - b. Use a DMM or other voltage measuring device to confirm the circuit is de-energized.
 - c. If the circuit in which the battery is installed has a disconnect, open the disconnect to isolate the battery.
 - d. Set both the battery BMS and the breaker to the OFF position.
 - e. Use a DMM or other voltage measuring device to confirm the circuit is de-energized.

2. Wire the inverter.

Use the HELIOS ESS Terminal Connector Set (950-0072) with 2/0 AWG (70 mm²) or 1/0 AWG (55 mm²) cables and appropriately sized ring terminals to create your own cables and wire the batteries to the inverter.

Or alternately, you can use the Battery to Inverter Power Cables 2/0 AWG (950-0070) or 1/0 AWG (950-0071) to wire the batteries to the inverter. Select the cable compatible with your inverter and inverter settings.

- a. Ensure the cable connections are clean and in working order.
- b. Connect the positive battery cable to a positive battery terminal on the inverter.
- c. Connect the negative battery cable to a negative terminal on the inverter.

NOTE

The following example uses two pairs of cables between the battery and the inverter.

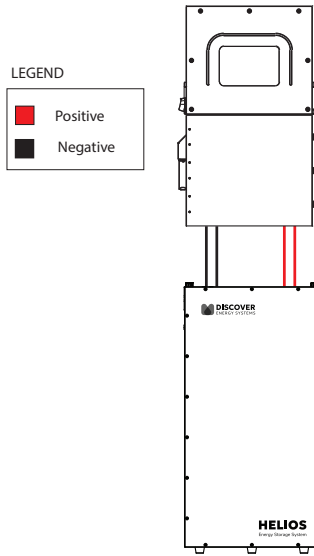

Figure 15. Wiring for One Battery

3. Connect the positive battery cables to the receiving pins of the positive battery terminals and push down to enable the connection. Refer to [9.4.3 Terminal Connections and Hardware](#).

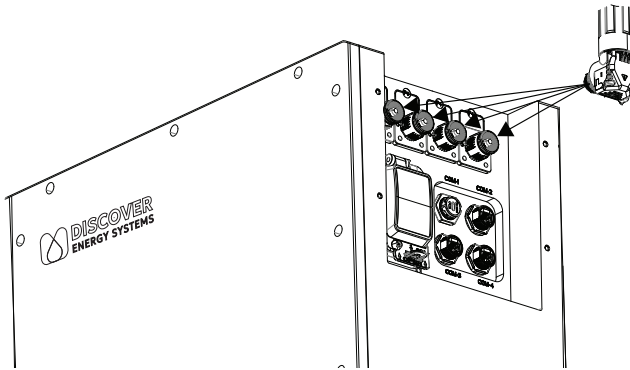

Figure 16. Connect Cables to Battery Terminals

4. Connect the negative battery cables to the receiving pins of the negative battery terminals and push down to enable the connection.
5. Connect the CAN communication cable. See [9.8.2](#) or [9.8.3](#).
6. Set the battery breaker ON (close).
7. Set the battery BMS ON (ON/OFF key).
8. Close the disconnect if it is open.

NOTICE

- Avoid short circuits. Short circuits will damage the battery and void the warranty.
- Failure to securely lock the ends of battery cables to the receiving pins on the battery will increase resistance and lower voltage, leading to burnout of the terminals and voiding of the warranty.
- Some inverter-chargers support temperature-compensated charging. Disable temperature compensated charging on the charger or inverter.
- Do not use or install a battery temperature sensor.

9.6 Parallel Battery Installation

⚠ CAUTION

FIRE HAZARD

Use cables that meet specifications. Undersized cables can become hot and may potentially catch fire.

Failure to follow these instructions may result in injury.

NOTICE

Some inverter-chargers support temperature-compensated charging. Disable temperature compensated charging on the charger or inverter.

Batteries used in a parallel system must meet the following requirements:

- Same model. Batteries must be the same model.
- Equal voltage. The battery has a Pre-Charge System that allows you to connect batteries at different SOC. The best practice is to confirm batteries are within 50 mV (0.05 V) of each other before installing them in parallel.

Battery Cables

- Minimum cable length. Select a location that minimizes the length of battery cables to reduce voltage drop from the impedance.
- The cables between batteries should be the same gauge and of equal length.
- Connectors. Battery terminal connections require specific connectors. Refer to [8. OPTIONAL ACCESSORIES](#).

NOTE

Use busbars to connect HELIOS ESS batteries in parallel,

9.6.1 Parallel Battery Installation Procedure (Busbar)

The following instructions describe how to connect batteries in parallel through busbars. Size the busbars so that they are capable of handling the maximum total charge and discharge current capacity of the loads and batteries.

The inverter connection is not identified as this can vary depending on the inverter type, number of inverters, and distance from the busbar.

CAUTION

ELECTRIC SHOCK AND FIRE HAZARD

- Take precautions to avoid bridging the terminals.
- Do not contact the terminals with metal mountings, fixtures, or body parts.

Failure to follow these instructions may result in injury.

NOTICE

All DC positive and DC negative cables from the busbar to each battery should be the same gauge and same length.

Install equipment following the standards set by the local authority having jurisdiction.

1. Prepare the battery for wiring.
 - a. If the inverter is wired to a power source, open the disconnect and set the inverter OFF.
 - b. Use a DMM or other voltage measuring device to confirm the circuit is de-energized.
 - c. If the circuit in which the battery is installed has a disconnect, open the disconnect to isolate the battery.
 - d. Set both the battery BMS and the Breaker to the OFF position.
 - e. Use a DMM or other voltage measuring device to confirm the circuit is de-energized.
2. Wire the batteries.

Use the HELIOS ESS Terminal Connector Set (950-0072) with 2/0 AWG (70 mm²) or 1/0 AWG (55 mm²) cables and appropriately sized ring terminals to create your own cables and wire the batteries to the inverter.

Or alternately, you can use the Battery to Inverter Power Cables 2/0 AWG (950-0070) or 1/0 AWG (950-0071) to wire the batteries to the inverter. Select the cable compatible with your inverter and inverter settings.

- a. Ensure the cable connections are clean and in working order.
- b. Confirm the power cables are capable of carrying the normally expected current in the system, plus a margin of safety.
- c. Push the ends of the positive (red +) power cables to the receiving pins on each battery's positive terminals to secure the connection. Refer to [9.4.3 Terminal Connections and Hardware](#).

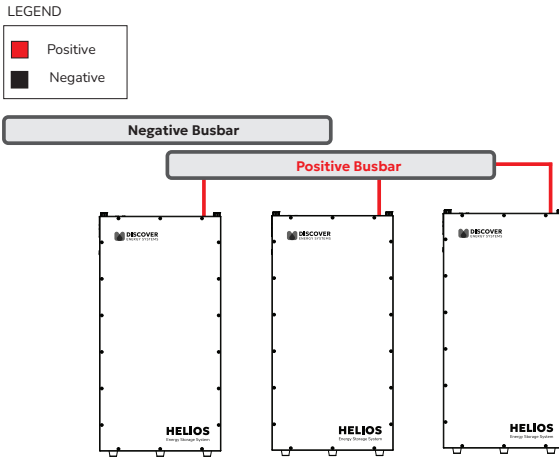

Figure 17. Wiring Battery Positive Terminals to Positive Busbar

- d. Connect the other end (ring terminal) of the positive battery cables to the positive busbar.
- e. Push the ends of the negative (black –) power cables to the receiving pins on each battery's negative battery terminals to secure the connection. Refer to [9.4.3 Terminal Connections and Hardware](#).
- f. Connect the other end (lugs) of the negative battery cables to the negative busbar.
- g. Repeat until all the batteries are connected to the busbars.

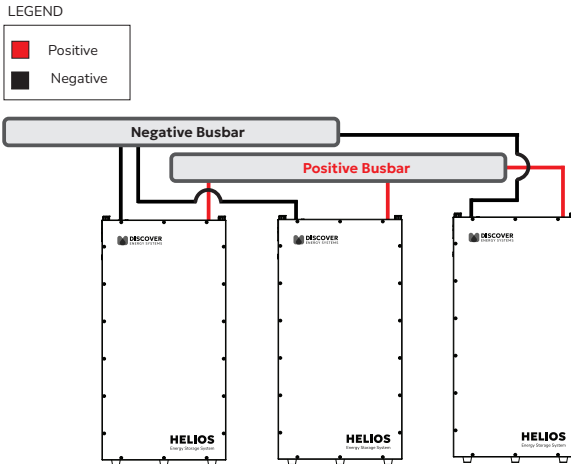

Figure 18. Wiring Battery Negative Terminals to Negative Busbar

9.7 Grounding

At the top of the HELIOS ESS battery is a grounding screw.

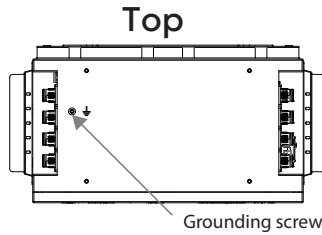

Figure 19. Grounding Screw at Top of HELIOS ESS Battery

9.7.1 Grounding the Batteries

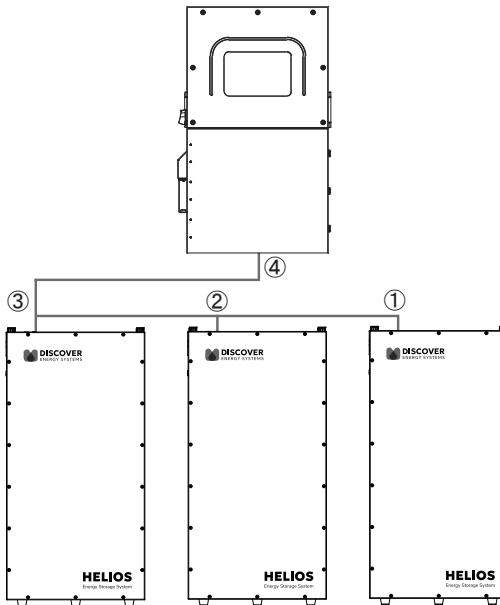

Figure 20. Grounding Multiple Batteries

1. Ground the first battery. Secure an appropriately sized grounding wire to the grounding screw on the farthest battery. Refer to your applicable code and check with the authority having jurisdiction to confirm local requirements. If this is the only battery in the system, jump to step 3. Otherwise, go to step 2.
2. Ground the second or more batteries. Pass the wire from the previous battery and secure the wire to the grounding screw on this battery. Secure another grounding wire to the grounding screw on this battery. Repeat until all the batteries are wired.
3. Ground to the inverter. Pass the wire from the last grounded battery to the inverter's grounding port.

9.8 Closed-Loop Communication

The HELIOS ESS battery supports closed-loop communication using two different methods.

1. With LYNK II Gateway. Connect CAT6 or higher cables between the COM3/COM4 port on the HELIOS ESS battery and the LYNK II Gateway, and between the LYNK II Gateway and the CAN port on the inverter.

For a list of inverters supported by the LYNK II Gateway and for information on configuring the LYNK II, refer to the [LYNK II Installation and Operation Manual \(805-0033\)](#).

2. Without LYNK II Gateway. The COM2 port on the HELIOS ESS battery enables connecting directly with most brands of inverters with a CAT6 or higher cable to the corresponding CAN port on the inverter.

For the list of inverters that support closed-loop communication without the LYNK II, refer to [A.3 HELIOS ESS Closed-Loop Communication - Supported Inverters](#).

9.8.1 LYNK Network

The COM3/COM4 ports on the HELIOS ESS battery allow communication with other LYNK-enabled devices on the LYNK network.

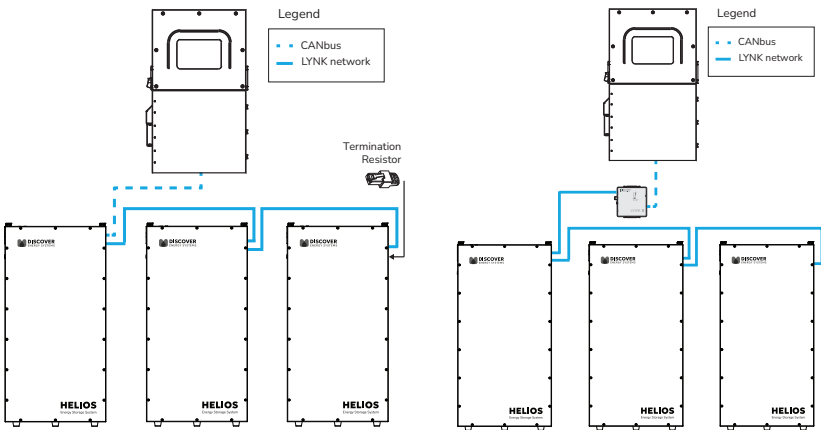

Figure 21. LYNK Network in Closed-Loop Communication With and Without LYNK II

Networking Guidelines

- Separate data and power cables. Allow for separation between data and power cables. Avoid data interference by running network cables separately from power cables.
- Allow for LYNK Network cable slack. Ensure that LYNK Network cables are slack and not in tension.
- Isolate the LYNK Network. Do not mix other networks with the LYNK Network.

NOTICE

Mixing the LYNK Network with other networks may result in equipment malfunction and damage.

9.8.2 Setting Up Closed-Loop Communication with the LYNK II Gateway

NOTICE

Refer to the [LYNK II Installation and Operation Manual \(805-0033\)](#) for information on setting up the LYNK II Communication Gateway for your particular inverter-charger.

If using the LYNK II Communication Gateway, connect the CAT6 communication cable from the inverter-charger to the LYNK device and then to each battery.

1. Attach the CAT6 or higher cable from the inverter to the LYNK II Communication Gateway's CAN port.

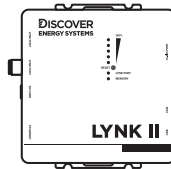

Figure 22. LYNK II Communication Gateway

2. Attach another CAT6 or higher cable to the LYNK II Communication Gateway's LYNK port, then attach the other end of the CAT6 or higher cable to COM3 or COM4 (LYNK port) on the battery.
3. If paralleling multiple HELIOS ESS batteries, attach CAT6 or higher cables to the COM3/COM4 ports to connect all the batteries. Attach a CAT6 or higher cable to COM3 or COM4 (LYNK port) on the first battery to COM3/COM4 on the next battery, and so on, until all the batteries are connected.

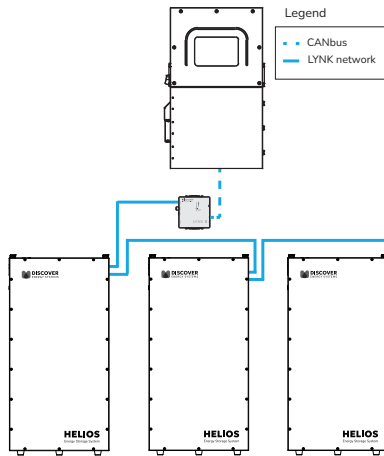

Figure 23. LYNK II Connection Between Inverter and Batteries

Testing and Verification of the LYNK Network

Perform network verification with the LYNK II Communication Gateway (950-0025).

1. If the LYNK Network Bus indication LED is illuminated, power and communication for the LYNK network are active.
2. Use LYNK ACCESS software through a computer to confirm the number of batteries in the LYNK network.
3. Use LYNK CLOUD to remotely monitor and troubleshoot the batteries.

9.8.3 Setting Up Closed-Loop Communication without the LYNK II Gateway

The HELIOS ESS battery supports closed-loop communication without the LYNK II Gateway for many inverter-chargers. Refer to [A.3 HELIOS ESS Closed-Loop Communication - Supported Inverters](#) for the list of supported inverter-chargers.

Depending on the inverter model, you can use CAT6 or higher straight cables or modified cables. Refer to [A.3.1 Cables for Closed-Loop Communication Without LYNK II](#) for specifications on the communication cable for your inverter.

1. After confirming the HELIOS ESS supports CAN communication with your inverter without the LYNK II, and after setting up the appropriate CAT6 or higher cable, attach it from the inverter's CAN port to the HELIOS ESS battery's COM2 port (CAN port).
2. If paralleling multiple HELIOS ESS batteries, attach CAT6 or higher cables to the COM3/COM4 ports to connect all the batteries. Attach a CAT6 or higher cable to COM3 or COM4 (LYNK port) on the first battery to COM3/COM4 on the next battery, and so on, until all the batteries are connected.

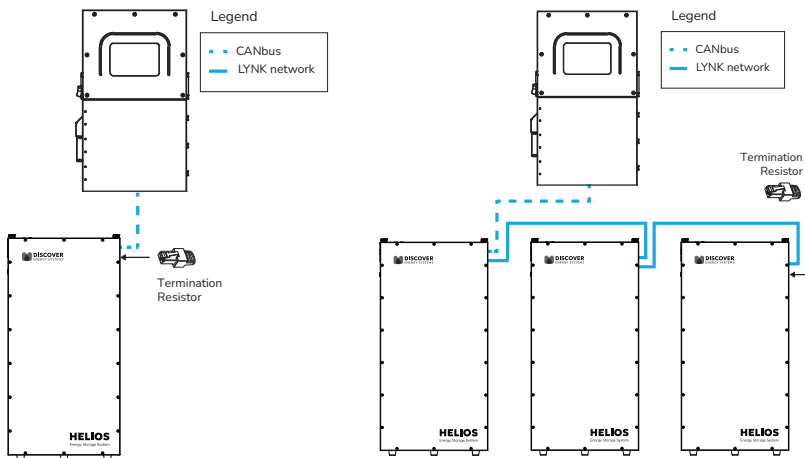

Figure 24. Closed-Loop Communication Without LYNK II

- When using HELIOS ESS batteries supplied with a termination resistor, insert the termination resistor to either the COM3 or COM4 port on the last battery.

NOTE

When setting up closed-loop communication without the LYNK II Communication Gateway with HELIOS ESS batteries that come with a termination resistor, attach it to the battery at the end of the LYNK network.

10. OPERATION

The BMS prevents battery operation outside of specified operating conditions. Understand each of these protections and how to set up the system accordingly. Refer to [Table 3-5, HELIOS ESS Protection Specifications](#).

NOTICE

Intentional bypassing of the BMS to operate the battery outside maximum and minimum limits void the warranty.

10.1 Low Voltage Cut-Off

As controlled by the application, program the low voltage cut-off at or above the Low Voltage Disconnect in [Table 3-1, HELIOS ESS Electrical Specifications](#). This action disconnects the load before the BMS enters low voltage protection.

10.2 State of Charge

A voltage-based battery meter designed for lead-acid batteries will not provide an accurate state-of-charge (SOC) for lithium batteries. The LYNK II Communication Gateway (950-0025), available from Discover, can be used to communicate an accurate state of charge to other devices.

NOTICE

Storing or leaving the battery at 0% SOC will lead to irreversible damage and void the warranty.

10.3 Charging

Each electrical system will have different characteristics and balance-of-system components. Charger settings may require modifications to optimize system performance.

NOTICE

- Confirm that the charging device cannot produce transient spikes that exceed the published terminal voltage limits for the battery.
- Confirm the charging curve meets the battery's charging requirement.
- Never charge a visibly damaged or frozen battery.
- If the battery is stored in a cold environment, it may become frozen and may not accept a charge. Be aware of the supported Charge Temperature range (refer to [3.3 Environmental Specifications](#)) for your battery and recharge before it approaches 0% SOC.

10.3.1 Closed-Loop Charging

Closed-loop charging is a method whereby the battery communicates with a charger and requests a specific charge voltage. Closed-loop charging reduces charge time and increases balancing efficiency compared to open-loop charging.

The HELIOS ESS battery can communicate over a CAT6 or higher cable to support closed-loop charging with the inverters listed in [Table A-1, Closed-Loop Communication with Inverters](#). Whether the communication cable is a standard patch cable or requires customized wire pin outs for the RJ45 connectors depends on the inverter manufacturer.

The HELIOS ESS supports closed-loop charging with many other inverter-chargers when combined with the LYNK II Communication Gateway. Refer to the appropriate Application Note available from discoverenergysys.com for the set up of closed-loop parameters and integration with specific brands of solar inverter-chargers, solar charger controllers, mobile inverter-chargers, and industrial chargers.

10.3.2 When to Charge the Battery

- **Opportunity charging is OK.** Charging the battery after every use will not reduce its life.
- **Partial State-of-Charge is OK.** If the battery SOC is greater than 10% at the end of discharge, it does not require an immediate charge. However, do not continually leave

the battery in a partial state of charge as that will reduce its performance as battery cells will become unbalanced.

Every 4 cycles, fully charge the battery so the inverter-charger reaches the charge termination criteria. This ensures the battery cells are balanced and that each battery cell is fully charged.

- **Charge if below 10% SOC.** If the battery has been discharged below 10% SOC, it must be charged within 24 hours to avoid permanent damage to the battery. Otherwise, irreversible damage to the battery cells will occur in a very short period of time.
- **Low charge current extends life.** Charging at 50% of nominal current or lower helps extend the battery cycle life.
- **Charge within the proper temperature range.** Ensure that charging is within the charge temperatures specified in [Table 3-4, HELIOS ESS Environmental Specifications](#).

NOTICE

- The battery must be charged within 24 hours if discharged below 10% SOC. Otherwise, irreversible damage to the battery cells will occur in a very short period of time and void the warranty.
- Do not continually leave the battery in a partial state of charge as that will unbalance the battery cells. Fully charge the battery every 4 cycles so each battery cell is fully charged. If the end of charge criteria is not regularly performed, multiple balancing charges may be required to fully charge each battery cell.
The following are two ways to perform a balancing charge.
 - Reduce charge termination to 100 mA and maintain 55.2 V for 10 hours.
 - Charge in a closed-loop configuration.

NOTE

When the HELIOS ESS battery cells are between -25°C (-13°F) and 5°C (41°F) and either connected to a charging source or SOC is 50% or more, energy is diverted to the internal heater until the battery cells reach 8°C (46.4°F). If the BMS triggered the Under-temperature in Charge protection, the battery will not allow charging until the cell temperature is 4°C (39.2°F).

10.4 Charging Profile

The Power Conversion device will require setting up a charging profile even if you use closed-loop charging. Using the controller of the Power Conversion device, set up a charging configuration with a Lithium charge profile that matches the charge and discharge settings. Refer to [Table 3-1, HELIOS ESS Electrical Specifications](#), for charging parameters.

Refer to the appropriate Application Note from discoverenergysys.com for setting up closed-loop parameters and integrating inverter-chargers and battery chargers.

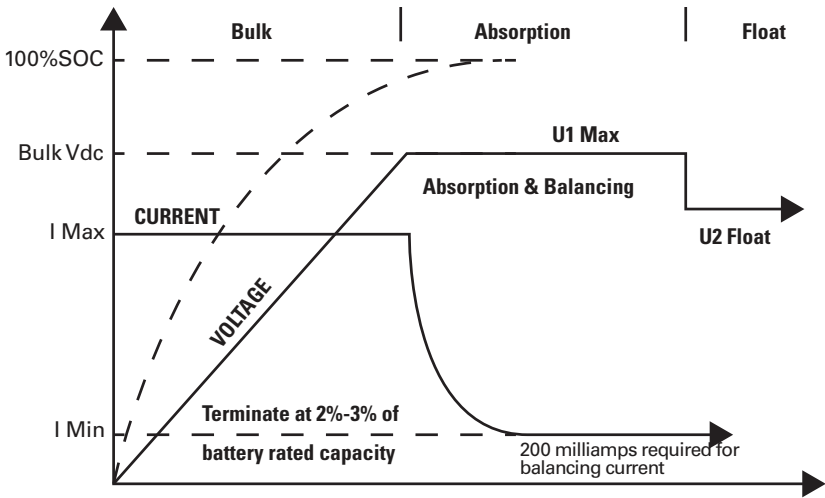

Figure 25. Charge Graph

NOTICE

- Charge with a Lithium charge profile matching the specifications of the HELIOS ESS battery.
- Do not charge using a lead-acid charging profile. Charging using a lead-acid profile will void the warranty.

NOTE

Charging at 50% of nominal current or lower will extend the battery cycle life.

10.4.1 Bulk Charge

Bulk phase. The Bulk Charge is the first phase of the charging process, called the constant current phase. This phase is when the charger's maximum current is directed to the battery until reaching the desired voltage. The Bulk phase will recharge the battery to approximately 90-95% SOC.

A single-stage charge may be appropriate if the charging source is a generator or other charge source that is inefficient at low output current. A single-stage charge will only complete the Bulk phase portion of the charge curve. This method should return the battery to 90-95% SOC.

Refer to [Table 3-1, HELIOS ESS Electrical Specifications](#), for charging parameters.

10.4.2 Absorption Charge

Absorption phase. The second phase of the charging process is Absorption Charge, also called the constant voltage phase. In this phase, the charger reduces current accordingly to maintain the desired voltage.

Refer to [Table 3-1, HELIOS ESS Electrical Specifications](#), for charging parameters.

10.4.3 Equalization Charge

CAUTION

FIRE AND BURN HAZARD

Do not perform an equalization charge on the HELIOS ESS battery.

Failure to follow these instructions may result in injury.

Do not equalize charge the HELIOS ESS battery. Equalization charging is intended only for lead-acid batteries. An equalization charge is a purposeful overcharge that targets a voltage above the standard charge voltage to remove sulphate crystals that form on lead-acid plates over time.

10.4.4 Float Charge

Float phase. Float charge, the third phase of charging, is optional. During this stage, the battery is maintained at 100% SOC for extended periods, counteracting any self-discharge or parasitic loads.

- Not necessary. Float charging is not required.

Refer to [Table 3-1, HELIOS ESS Electrical Specifications](#), for float parameters if needed.

11. ROUTINE INSPECTION

CAUTION

ELECTRIC SHOCK HAZARD

- Do not touch the energized surfaces of any electrical component in the battery system.
- Before servicing the battery, follow all procedures to fully de-energize the battery system.
- Follow [1.4 Safe Handling Procedures](#) when working with the battery.

Failure to follow these instructions may result in injury.

Periodically inspect the battery:

1. Ensure that all DC cables are secure and fasteners are torqued properly.
2. Inspect and clean network and battery connectors of dirt and debris.
3. Ensure all networking cables and connectors are secure and tight.
4. Ensure that the installation location is clean and free from debris.

5. Inspect for cracks or bulging in the battery case.
6. Replace any damaged batteries.
7. Replace any damaged cables.

12. STORAGE

Leaving the battery connected to a trickle load or power electronics will cause the battery to discharge during storage. Without any load, the battery will self-discharge by approximately 3.5% per month while in storage. After storage, charge the battery to 100% SOC and perform at least one full discharge and charge cycle before returning the battery to service.

1. **Store at 95% SOC or more.** To store the battery for up to 6 months, store the battery at 95% SOC or more. It must remain disconnected from all loads and power electronics during storage.
2. **Switch OFF the battery.** Set the battery to OFF.
3. **Check SOC every six months.** Recharge the battery to above 95% SOC every six months.
4. **Proper storage temperature.** Ensure storage is within the temperatures specified below.
 - 1 Month storage temperature -20°C to 55°C (-4°F to 131°F)
 - 6 Month storage temperature -10°C to 30°C (14°F to 86°F)

NOTICE

- Leaving the battery connected to a load or power electronics during storage may subject the battery to discharge, resulting in irreversible damage and voiding the warranty.
- Storing the battery outside specified temperatures will result in irreversible damage and void the warranty.

NOTICE

- Storing or leaving the battery at 0% SOC will result in irreversible damage and void the warranty.
- If the battery is stored in a cold environment, it may become frozen and may not accept a charge. Be aware of your battery's supported Charge Temperature range (refer to [3.3 Environmental Specifications](#)) and recharge before it approaches 0% SOC.
- Allowing the battery to self-discharge below an open-circuit voltage of 3.0 VPC will cause irreversible damage and void the warranty.

13. BATTERY FIRMWARE AND DATA LOGS

Always ensure the battery is using the latest firmware.

Connect LYNK ACCESS software for 64-bit Windows 10 / 11 to either the LYNK II Communication Gateway (USB Type B connector) or to the HELIOS ESS battery's USB Type C port (see [Figure 4. HELIOS ESS Battery Components](#), Item #13) to update the battery firmware and to download data logs from the battery.

LYNK II Communication Gateway devices are available from Discover dealers and distributors. Get the latest LYNK ACCESS software and battery operating firmware from the Discover website at discoverenergysys.com.

14. TROUBLESHOOTING

Accurate troubleshooting and warranty claims require data logs from each battery.

To share data logs LYNK ACCESS software for 64-bit Windows 10 / 11 is required to download data logs from each battery in the system:

- Connect to the LYNK II Communication Gateway through a USB connection with the LYNK II Communication Gateway device to download the data logs from all the batteries in the system.
- When the system does not use the LYNK II Communication Gateway device, connect to the USB Type C port on the HELIOS ESS battery to download the data logs from that one battery. If the system includes multiple batteries, download the data logs from each battery, one by one.

15. RELATED INFORMATION

For warranty information, refer to [885-0098 Discover HELIOS ESS Battery Warranty Policy](#), available from the Discover website at discoverenergysys.com.

16. GLOSSARY OF TERMS, ABBREVIATIONS, AND ACRONYMS

AFB Arc Flash Boundary	LFP LiFePO ₄ , Lithium Iron Phosphate
BMS Battery Management System	RMS Root Mean Square
DMM Digital Multimeter	SOC State of Charge
DOD Depth of Discharge	VPC Volts Per Cell
IBF Bolted Fault Current	

APPENDIX

A.1 HELIOS ESS Commissioning Checklist

Use this checklist to confirm the correct installation and function of the HELIOS ESS during the commissioning of the complete energy storage system. This checklist is only for the installation and operation of the HELIOS ESS . Further system-level functionality checks and tests must be performed once the full system is interconnected with the HELIOS ESS to complete commissioning.

Battery Installation

PROCEDURE	CHECK
1. Ensure that the battery is securely anchored to the Wall-Mount Bracket. Verify that:	
<ul style="list-style-type: none"> • All FOUR screws are tight 	
<ul style="list-style-type: none"> • The battery and Wall-Mount Bracket are secure and the wall shows no signs of losing integrity. 	
2. Check the battery cable connections on the inverter. Verify that:	
<ul style="list-style-type: none"> • The positive battery cables (RED) are fastened to the correct positive terminal on the inverter and secured using the torque as recommended by the inverter manufacturer. 	
<ul style="list-style-type: none"> • The negative battery cables (BLACK) are fastened to the correct negative terminal on the inverter and secured using the torque as recommended by the inverter manufacturer. 	
3. Check the battery cables and connections to the battery. Verify that:	
<ul style="list-style-type: none"> • The positive battery cables are connected to the correct positive battery terminals. 	
<ul style="list-style-type: none"> • The negative battery cables are connected to the correct negative battery terminals. 	
<ul style="list-style-type: none"> • Each battery terminal connection is latched in place. <p>Note: You should not be able to pull off the connector without pressing the release button on the side of connector.</p>	
4. When closed-loop communication with the inverter is set up without the LYNK II Gateway, and if a termination resistor is provided with the battery, confirm the termination resistor is connected to the last battery in the LYNK Network (even for 1 battery systems).	
5. If applicable, check the Conduit Box. Verify that:	
<ul style="list-style-type: none"> • The conduit box, installed between the inverter and battery, is secure and not loose. 	

PROCEDURE	CHECK
<ul style="list-style-type: none"> The cables passing through the conduit box are not rubbing against any sharp edges. 	
<ul style="list-style-type: none"> The cables are not overly bent or curled as a result of passing through grommets and conduit. 	
<p>6. Equipment is bonded as required per the local installation code. Verify that:</p>	
<ul style="list-style-type: none"> A suitable-sized bonding wire is connected from the ground terminal on the battery to a marked bonding terminal. 	
<p>7. Additional disconnects and overcurrent protection required by the installation code are installed and suitably rated. Verify that:</p>	
<ul style="list-style-type: none"> Overcurrent protection is suitably rated for min 60 Vdc, 300 A per DC output. 	
<ul style="list-style-type: none"> Disconnect is rated for min 60 Vdc, and for operating under load of 200 A per DC output. 	

Battery Operation Verification

Verify the items below to confirm that the protection functions of the batteries are working correctly.

PROCEDURE	CHECK
<p>1. Confirm that each battery breaker is CLOSED, and turn on each battery using the ON/OFF push button. Verify that:</p>	
<ul style="list-style-type: none"> The battery status LED turns a solid ORANGE. <p>NOTE:</p> <ul style="list-style-type: none"> If the LED does not turn ON, there is an issue with the battery. Contact Technical Support. If the LED flashes, a fault has occurred. Use LYNK Access software to find details about the fault. 	
<p>2. Repeat step 1 for all the batteries in the system.</p>	

A.2 HELIOS ESS Decommissioning Checklist

This checklist is only for the battery energy storage system; further system-level decommissioning procedures on the full system may be required. Refer to the manuals of connected DC loads, power conversion equipment, and other components in the system.

Disassemble, Recycle, and Dispose

PROCEDURE	CHECK
1. Open disconnect devices to ensure there is no electrical connection to any externally connected Power Conversion Equipment.	
2. Turn off each battery one by one using the battery ON/OFF push buttons.	
3. Use a multimeter to verify there is no voltage on the battery terminals.	
4. Disconnect and remove battery cables from the inverter and batteries.	
5. Disconnect and remove CAT6 or higher communication cables.	
6. If using conduit box:	
• Disconnect and remove conduit.	
• Remove cable glands and grommets.	
• Remove the conduit box.	
7. Remove the screws holding the battery to the Wall-Mount Adapter.	
8. Using a two or three-person lift or mechanical aid, detach the battery from the Wall-Mount Adapter.	
9. Remove the Wall-Mount fasteners and detach the Wall-Mount Bracket.	
10. Recycle all recyclable components.	
11. Dispose of unrecyclable components following local waste disposal guidelines.	

A.3 HELIOS ESS Closed-Loop Communication - Supported Inverters

The HELIOS ESS battery supports closed-loop communication using two different methods:

1. Direct (without LYNK II Gateway).
2. LYNK II Gateway.

The following table identifies the closed-loop communication methods available to supported inverter-chargers.

Table A-1, Closed-Loop Communication with Inverters

Inverter	Closed Loop without LYNK II		Closed Loop with LYNK II	LYNK ACCESS with LYNK II	LYNK CLOUD with LYNK II
	Straight Cable	Create Your Own Cable			
Deye SUN 3-16K single-phase Hybrid Inverters SUN 5-12K three-phase Hybrid Inverters	Yes	No	Yes	Yes	Yes
Luxpower LXP-LB-US 8/10/12K Hybrid Inverter SNA-US 6000 ECO Hybrid Inverter	Yes	No	Yes	Yes	Yes
NOARK 3K - 8K single-phase and 5K - 12K three-phase low-voltage Hybrid Inverter	Yes	No	Yes	Yes	Yes
Schneider Electric XW Pro 6848 NA 120/240 XW Pro 6848 NA 120 XW Pro 8548 IEC 230 MPPT 60-150 MPPT 80-600 MPPT 100-600	No		Yes	Yes	Yes
Schneider Electric (Legacy) Conext XW+ 5.5/6.8 Conext XW+ 7.0/8.5 Conext MPPT 60-150 Conext MPPT 80-600 Conext MPPT 100-600	No		Yes	Yes	Yes
Sol-Ark 5K to 15K-P (Outdoor) and 12K to 15K-2P (Outdoor)	Yes	No	Yes	Yes	Yes
Sol-Ark (Legacy) 8K - 12K Hybrid Indoor inverters	No	Yes	Yes	Yes	Yes
SUNSYNK 3K - 16K single-phase and 8K - 12K three-phase low-voltage Hybrid Inverters	Yes	No	Yes	Yes	Yes
Victron Energy Color Control GX Venus GX VE.CAN Devices	No	Yes	Yes	Yes	Yes

A.3.1 Cables for Closed-Loop Communication Without LYNK II

The communication cable between the HELIOS ESS battery and the connected inverter-charger can differ depending on the pin outs used for CAN communication by the inverter-charger.

The following identifies the cable requirements for inverter-chargers the HELIOS ESS battery supports for closed-loop communication without using the LYNK II Communication Gateway.

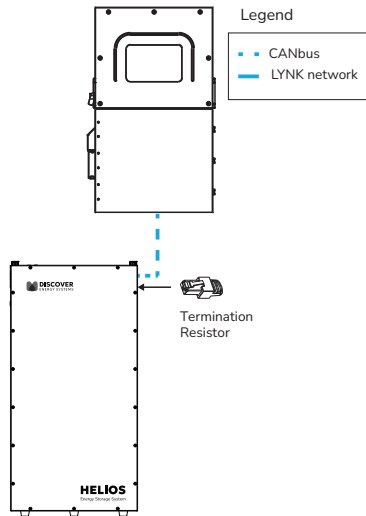

Figure 26. Closed-Loop Communication Without LYNK II

Straight Cable

The HELIOS ESS supports closed-loop communication with the following inverters through a CAT6 or higher cable. Refer to [Table A-1, Closed-Loop Communication with Inverters](#).

- Sol-Ark 5K to 15K-P (Outdoor) and 12K to 15K-2P (Outdoor)
- Deye SUN 3-16K single-phase, 5-12K three-phase Hybrid Inverters
- Luxpower LXP-LB-US 8/10/12K Hybrid, SNA-US 6000 ECO Hybrid Inverters
- NOARK 3K - 8K single-phase and 5K - 12K three-phase low-voltage Hybrid Inverters
- SUNSYNK 3K - 16K single-phase and 8K - 12K three-phase low-voltage Hybrid Inverters

Connect the CAT6 or higher cable from the battery's COM2 port directly to the CAN port on the inverter.

NOTICE

- Use a straight-through cable. Do not use a cross-over cable.
- Isolate unused pins. Crossing pin functions may cause system damage.
- Do not terminate unused wires to ground, power, or other functions.
- Mixing this communication line with the LYNK Network may result in equipment malfunction and damage.

Create Your Own Cable

The HELIOS ESS supports closed-loop communication with the following inverter-chargers through a modified CAT6 or higher cable. For the list of inverter-chargers that require you to create your own cable, refer to [Table A-1, Closed-Loop Communication with Inverters](#).

Legacy Sol-Ark

- (Legacy) Sol-Ark 8K - 12K Hybrid Indoor inverters

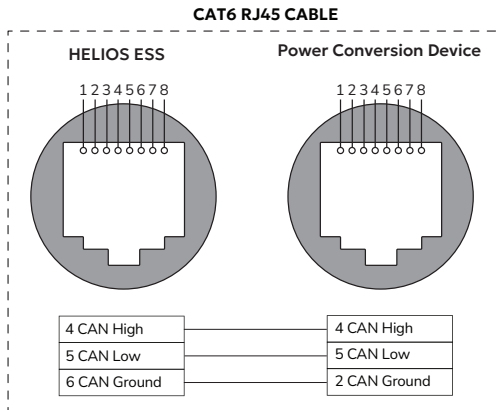

Figure 27. Create Your Own Cable (Legacy Sol-Ark)

Victron Energy

- Victron Energy Color Control GX, Venus GX, VE.CAN Devices

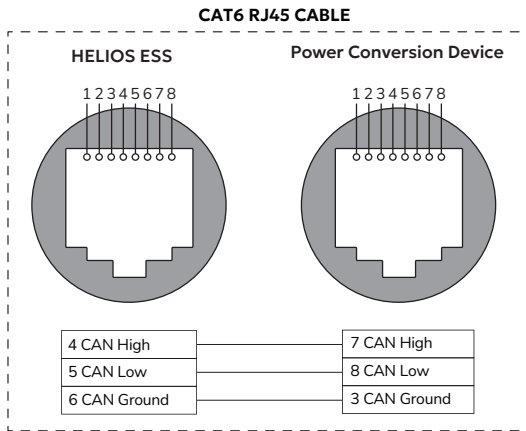

Figure 28. Create Your Own Cable (Victron Energy)

A.4 How to Calculate Minimum Battery Sizing

The following table identifies the minimum number of batteries required for inverter-chargers with the shown inverter Peak, Discharge, and Charge values. Using these values with the battery sizing information provided in [Table 3-9. HELIOS ESS DC Capacity Values for Sample Battery Systems](#), identify the minimum number of HELIOS ESS batteries required in the last column.

Table A-2, Example Battery Sizing for example inverters

Model	Inverter Peak	Max Continuous Discharge	Max Continuous Charge	HELIOS ESS Minimum per inverter
HELIOS ESS Battery	300 A	200 A	200 A	—
Inverter A	200 A	50 ADC	50 ADC	1
Inverter B	300 A	100 ADC	100 ADC	1
Inverter C	400 A	150 ADC	150 ADC	2
Inverter D	500 A	200 ADC	200 ADC	2
Inverter E	600 A	250 ADC	250 ADC	2
Inverter F	700 A	300 ADC	300 ADC	3

A.4.1 Calculating the minimum number of batteries per inverter

To determine the minimum number of batteries needed for optimal inverter performance, the battery's peak current, maximum continuous discharge current, and maximum continuous charge current must exceed the corresponding performance values of the inverter.

Inverter A: The HELIOS ESS battery's peak and discharge and charge currents are greater than the corresponding performance values of the inverter.

- One battery is the minimum required.

Inverter B: The HELIOS ESS battery's peak and discharge and charge currents are greater than or equal to the corresponding performance values of the inverter.

- One battery is the minimum required.

Inverter C: The HELIOS ESS battery's peak is less than the inverter, even though the battery's discharge and charge currents are greater than the corresponding currents of the inverter.

If we use two batteries, the total peak current of the batteries is greater than the peak current of the inverter.

- Two batteries are the minimum required.

Inverter D: The HELIOS ESS battery's peak is less than the inverter, even though the battery's discharge and charge currents are equal to the corresponding currents of the inverter.

If we use two batteries, the total peak current of the batteries is greater than the peak current of the inverter.

- Two batteries are the minimum required.

Inverter E: The HELIOS ESS battery's peak and discharge and charge currents are less than the inverter.

If we use two batteries, the total peak and discharge and charge currents of the batteries are greater than the corresponding performance values of the inverter.

- Two batteries are the minimum required.

Inverter F: The HELIOS ESS battery's peak and discharge and charge currents are less than the corresponding performance values of the inverter.

If we use two batteries, even though the total discharge and charge current of the batteries is greater than the corresponding currents of the inverter, the total peak current of the batteries is less than the peak current of the inverter.

If we use three batteries, the total peak current of the batteries is greater than the peak current of the inverter.

- Three batteries are the minimum required.

A.4.2 Calculating Inverter Peak Current

If the inverter manufacturer provides the surge power only, calculate the peak current using the following formula:

Inverter Peak (Amps) = (Inverter Surge Value) / (Inverter Efficiency %) / (48V: Low Battery Cut-Off)

For example, if the inverter's surge power is 24,000 watts and its CEC efficiency is 95%, the calculation with HELIOS ESS 48 V batteries is:

- Inverter Peak = 24,000 watts / 0.95 / 48 V

This results in a peak current of approximately 526 A.

To maximize inverter performance, two batteries (with a combined peak current of 600 A) are needed to support the inverter's peak current of 526 A. If the two batteries can also handle the maximum continuous charge and discharge currents, they can manage the inverter's charging and discharging needs.

A.5 Deye Inverter Configuration (Closed Loop Without LYNK II)

The HELIOS ESS supports closed-loop communication with the Deye inverters listed in [Table A-1. Closed-Loop Communication with Inverters.](#)

To enable communication between the inverter and batteries:

1. Connect a CAT6 or higher straight cable from the HELIOS ESS COM2 port to the CAN port of the Deye inverter-charger.

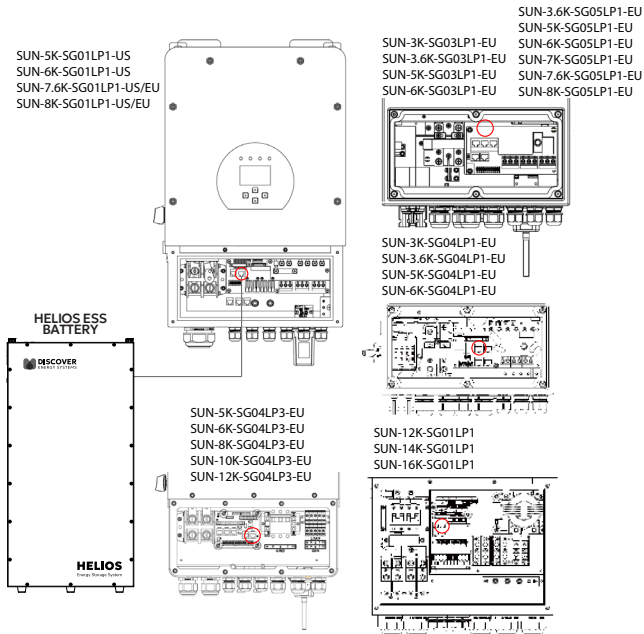

Figure 29. Deye CAN Connection

2. Configure the Inverter-Charger
 - a. Using the touch screen and keypad on the inverter-charger, navigate to **Main Screen > System Setup > Battery Setting.**
 - b. Specify the settings according to the instructions in the tables that follow to stop power conversion when there is a closed-loop communication error.
 - c. Touch the Up and Down arrows to scroll through the screens. Touch the checkmark button to save changes.
3. Exit and restart the inverter-charger.

NOTE

- If there is a break in communication between the HELIOS ESS battery and inverter-charger for more than ten seconds, the inverter-charger will safely stop operation, so long as the **BMS Lithium Batt** and the **BMS_Err_Stop** parameters are both enabled on the Deye inverter-charger. The inverter-charger will display an **F58 BMS Communication Fault** if communication is lost. The Deye inverter-charger will check every five minutes and resume closed-loop operation if communication is re-established.
- If communication cannot be reestablished and you need to resume operation, you may have to manually convert the Deye inverter to an open-loop configuration. For instructions on configuring open loop, refer to [A.5.1 Deye Inverter Configuration \(Open Loop\)](#).

NOTE

Depending on your system and particular use case, there may be other settings that require configuration. Refer to the inverter manual for information on these settings.

Main Screen > System Setup > Battery Setting

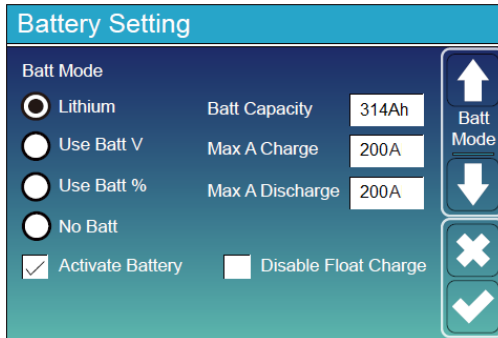

Figure 30. Battery Setting - Deye Closed-loop Charge Settings

Battery Setting (page 1)	
Batt Mode	Select the Lithium option to use the battery BMS.
Activate Battery	Select this check box.

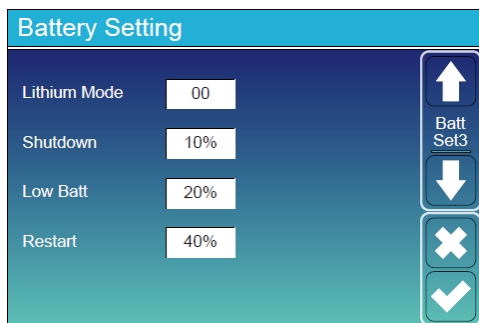

Figure 31. Battery Setting - Deye Closed-Loop Charge Settings

Battery Setting (page 3)	
Lithium Mode	Set this value to 00.
Shutdown	Adjust values to support the use case or keep the original values.
Low Batt	
Restart	

Main Screen > System Setup > Advanced Function

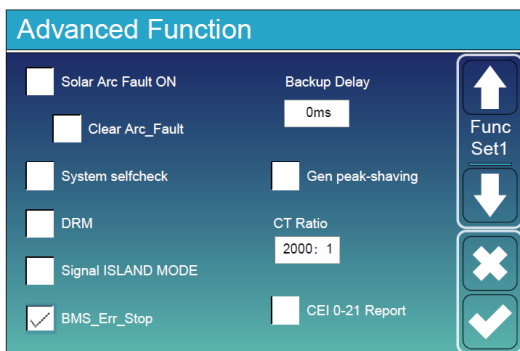

Figure 32. Advanced Function - Deye Closed-Loop Setting

Advanced Function	
BMS_Err_Stop	Select this check box to cause the inverter-charger to stop operating if there is a communication error.

A.5.1 Deye Inverter Configuration (Open Loop)

If closed-loop communication cannot be established and you need to resume operation, you may have to manually convert the Deye inverter to an open-loop configuration. Refer to the latest Discover Energy Systems documentation for battery values and the latest Deye documentation for menu navigation and details on the setup procedure.

NOTE

Depending on your system and particular use case, there may be other settings that require configuration. Refer to the inverter manual for information on these settings.

1. Set the Discover Lithium batteries to ON and set the inverter-charger to ON.
2. Using the touch screen and keypad on the inverter, navigate to **Main Screen > System Setup > Battery Setting**.
3. Specify the battery settings according to the instructions in the tables that follow. Touch the Up and Down arrows to scroll through screens.
4. Touch the check mark button to save changes.
5. Exit and restart the inverter-charger.

Battery Setting

Figure 33. Battery Setting - Deye Open-Loop Charge Settings

Battery Setting (page 1)	
Batt Mode	Select the Use Batt V option to use battery voltage for all the settings. (1)
Activate Battery	Select this check box.
Batt Capacity	Set to the number of Discover Lithium batteries x Ah capacity of each. For example, set to 628 Ah (2 x 314 Ah) for two HELIOS ESS 52-48-16000 batteries.

Battery Setting (page 1)

Max A Charge	<p>For a single inverter, set to the lesser value between the inverter's maximum charge rate or the quantity of attached batteries multiplied by the battery's maximum charge rating.</p> <p>For example:</p> <p>Single phase system with SUN-6K-SG01LP1-US inverter and two HELIOS ESS 52-48-16000 batteries</p> <ul style="list-style-type: none">• Set the SUN-6K-SG01LP1-US inverter to the lesser of the inverter's maximum charge rate of 135 A, or 400 A for two HELIOS ESS 52-48-16000 batteries that are each rated at a maximum charge rating of 200 A ($2 \times 200 \text{ A} = 400 \text{ A}$). <p>Three-phase system with three SUN-6K-SG04LP3 inverters and two HELIOS ESS 52-48-16000 batteries</p> <ul style="list-style-type: none">• For a three-phase system, set to the lesser value between the master inverter's maximum charge rate or the quantity of attached batteries multiplied by the battery's maximum charge rating divided by the number of inverters. For example, set the SUN-6K-SG04LP3 inverter to the lesser of the inverter's maximum charge rate of 150 A, or 133 A for two HELIOS ESS 52-48-16000 batteries that are each rated at a maximum charge rate of 200 A, and then divided by three inverters ($2 \times 200 \text{ A} \div 3 = 133.33 \text{ A}$).
Max A Discharge	<p>For a single inverter, set to the lesser value between the inverter's maximum discharge rate or the quantity of attached batteries multiplied by the battery's maximum discharge rating. For example, set the SUN-6K-SG01LP1-US inverter to the lesser of the inverter's maximum discharge rate of 135 A, or 400 A for two HELIOS ESS 52-48-16000 batteries that are each rated at a maximum discharge rating of 200 A.</p> <p>For a three-phase system, set to the lesser value between the master inverter's maximum discharge rate or the quantity of attached batteries multiplied by the battery's maximum discharge rating divided by the number of inverters. For example, set the SUN-6K-SG04LP3 inverter to the lesser of the inverter's maximum discharge rate of 150 A, or 133 A for two HELIOS ESS 52-48-16000 batteries that are each rated at a maximum discharge rate of 200 A and then divided by 3 inverters ($2 \times 200 \text{ A} \div 3 = 133.33 \text{ A}$).</p>

(1) To configure the open-loop parameters, do not select the Lithium parameter. Selecting the Lithium parameter enables the BMS for closed-loop communication.

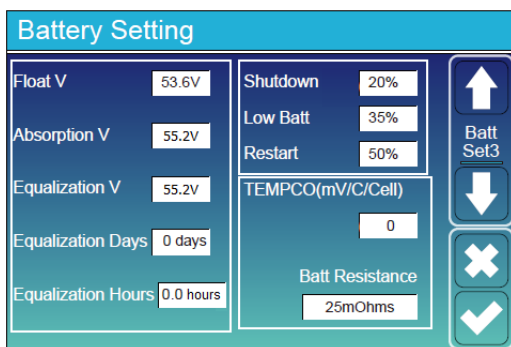

Figure 34. Battery Setting - Deye Open-loop Battery Settings

Battery Setting (page 3)	
Float V	53.6 V
Absorption V	55.2 V
Equalization V	Do not equalize Discover Lithium batteries
Equalization Days	
Equalization Hours	
Shutdown (%)	
Low Batt (%)	Inverter outputs a warning when the battery reaches the specified SOC.
Restart (%)	Inverter AC output continues when the battery reaches the specified SOC.
TEMPCO (mv/C/Cell)	Set to 0 mv/C/Cell. ⁽¹⁾
Batt Resistance	Keep the default value of 25 mOhms.

(1) Discover Lithium batteries do not require temperature compensation. Setting TEMPCO to 0 mv/C/Cell disables inverter controlled temperature compensation.

NOTE

For more information about configuring the Deye inverter-charger, refer to product documentation on the Deye website (deyeinverter.com) or the [LYNK II Deye User Manual \(805-0084\)](#).

A.6 Luxpower Inverter Configuration (Closed Loop Without LYNK II)

The HELIOS ESS supports closed-loop communication with the Luxpower inverters listed in [Table A-1. Closed-Loop Communication with Inverters.](#)

To enable communication between the inverter and batteries:

1. Connect a CAT6 or higher straight cable from the HELIOS ESS COM2 port to the CAN port of the Luxpower inverter-charger.

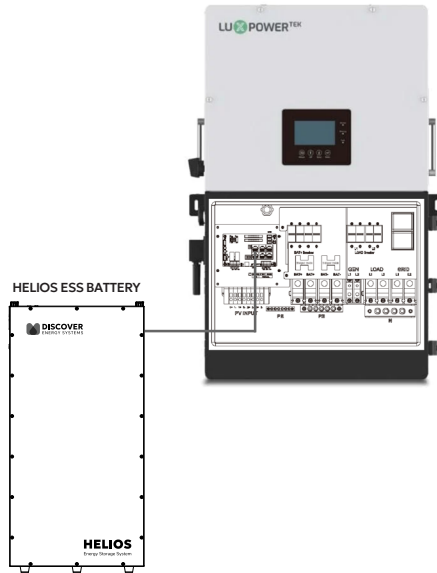

Figure 35. Luxpower CAN Connection

2. Configure the Inverter-Charger
 - a. If using multiple inverters, configure the Luxpower inverters to operate in parallel before setting the battery operation parameters.
 - b. When connecting communication cables for multiple Luxpower inverters that operate in parallel, set the CAN communication pins to ON for the first and last inverters. For details on connecting multiple inverters in parallel, refer to the inverter manual.

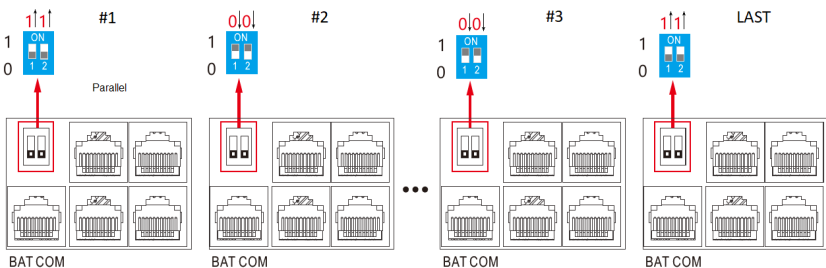





Figure 36. Pin Settings for Multiple Luxpower Inverters

- Using the inverter touch screen interface, touch the  Gear icon to set the properties as indicated in the following tables.
- Touch the  Up and  Down buttons to scroll through screens.
- Touch the  Set button to save changes on a screen.

NOTE

- When the Luxpower inverter is configured in a closed loop with Discover Lithium batteries and the communication breaks between the batteries and inverter, after about a minute, the inverter safely stops operation and displays an alarm. If communication is re-established, the Luxpower inverter resumes closed-loop operation within seconds.
- If communication cannot be reestablished and you need to resume operation, you may have to manually convert the Luxpower inverter to an open-loop configuration. For instructions on configuring open loop, refer to [A.6.1 Luxpower Inverter Configuration \(Open Loop\)](#).

NOTE

Depending on your system and particular use case, there may be other settings that require configuration. Refer to the inverter manual for information on these settings.

> Advanced

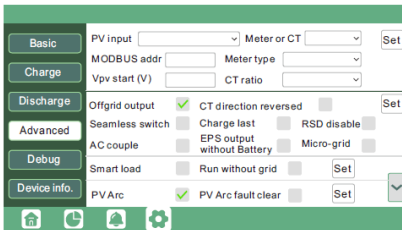

Figure 37. Advanced - Luxpower Screen 1

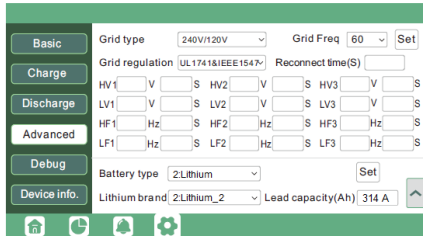

Figure 38. Advanced - Luxpower Screen 2

Advanced (Screen 2)

Battery Type	Select 2: Lithium .
Lithium brand	Select Lithium_2 .

 > Charge

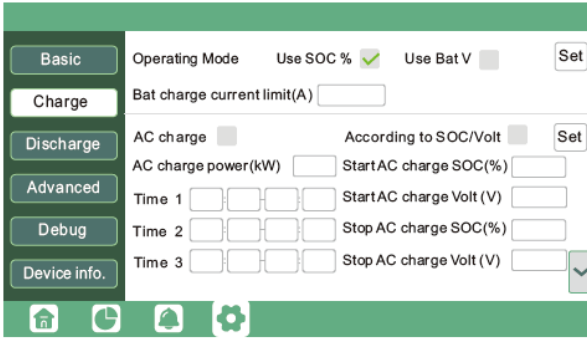

Figure 39. Charge - Luxpower Screen 1

Charge - Screen 1	
Operating Mode	Select the Use SOC % check box.
Bat charge current limit (A)	200 A x number of batteries

 > Discharge

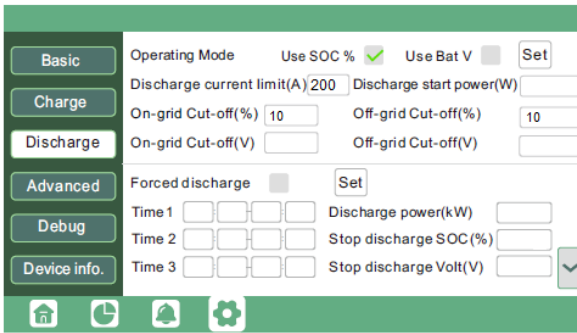

Figure 40. Discharge - Luxpower Screen 1





Discharge - Screen 1	
Operating Mode	Select the Use SOC % check box.
Discharge current limit (A)	200 A x number of batteries
On-grid cut-off (%)	The recommended value is 10% or more.
Off-grid cut-off (%)	

A.6.1 Luxpower Inverter Configuration (Open Loop)

If closed-loop communication cannot be established and you need to resume operation, you may have to manually convert the Luxpower inverter to an open-loop configuration. Refer to the latest Discover Energy Systems documentation for battery values and the latest Luxpower documentation for menu navigation and details on the setup procedure.

NOTE

Depending on your system and particular use case, there may be other settings that require configuration. Refer to the inverter manual for information on these settings.

1. Set the Discover Lithium batteries to ON and set the inverter to ON.
2. Using the inverter touch screen interface, touch the  Gear icon to set the properties as indicated in the following tables.
3. Touch the  Up and  Down buttons to scroll through screens.
4. Touch the  Set button to save changes on a screen.

> Advanced

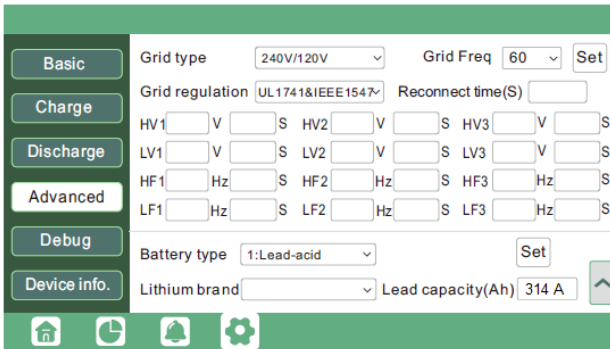

Figure 41. Advanced - Luxpower Screen 2

Advanced (Screen 2)	
Battery Type	Select 1: Lead-acid when operating the inverter and Lithium batteries in an open-loop configuration.
Lead capacity	314 A x number of batteries

 > Charge

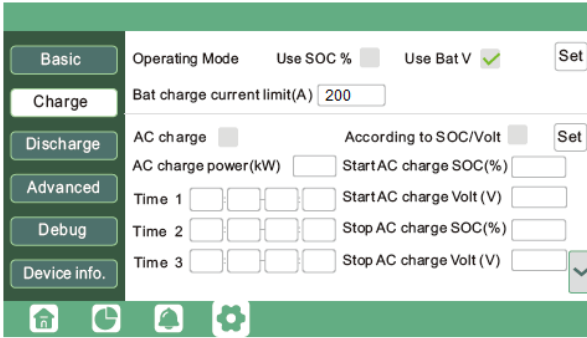

Figure 42. Charge - Luxpower Screen 1

Charge - Screen 1	
Operating Mode	Select the Use Bat V check box when operating the inverter in an open-loop charge configuration.
Bat charge current limit (A)	200 A x number of batteries

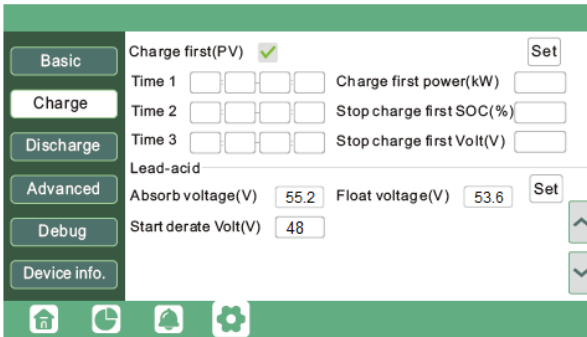

Figure 43. Charge - Luxpower Screen 2

Charge - Screen 2	
Absorb voltage (V)	55.2
Float voltage (V)	53.6
Start derate Volt (V)	48

 > Discharge

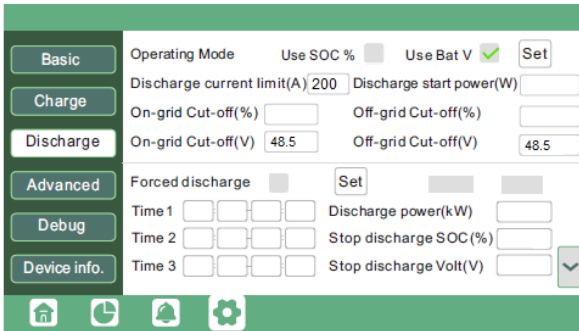

Figure 44. Discharge - Luxpower Screen 1

Discharge - Screen 1	
Operating Mode	Select the Use Bat check box when operating the inverter in an open-loop charge configuration.
Discharge current limit (A)	200 A x number of batteries
On-grid Cut-off (V)	Set to voltage greater than the Start derate Volt . The recommended value for the cut-off is 48.5 V or more.
Off-grid Cut-off (V)	

NOTE

For more information about configuring the Luxpower inverter-charger, refer to product documentation on the Luxpower website (luxpowertek.com) or the [LYNK II Luxpower User Manual \(805-0081\)](#).

A.7 Noark Inverter Configuration (Closed Loop Without LYNK II)

The HELIOS ESS supports closed-loop communication with the Noark inverter-chargers listed in [Table A-1. Closed-Loop Communication with Inverters.](#)

To enable communication between the inverter and batteries:

1. Connect a CAT6 or higher straight cable from the HELIOS ESS COM2 port to the CAN port of the Noark inverter-charger.

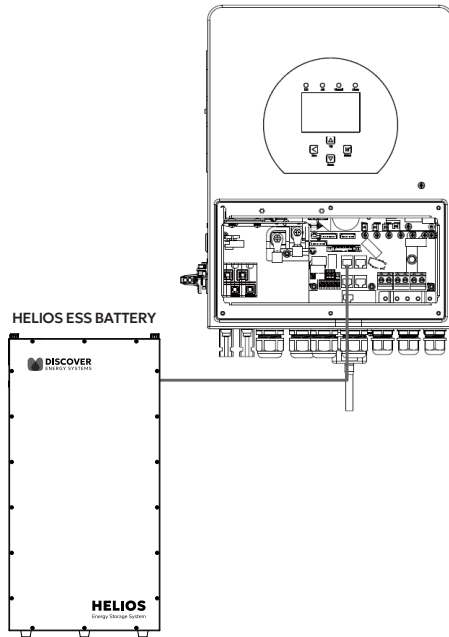

Figure 45. Noark CAN Connection

2. Using the touch screen and keypad on the inverter-charger, navigate to **Main Screen > System Setup > Battery Setting.**
3. Configure the Inverter-Charger. Specify the battery settings according to the instructions in the tables that follow to stop power conversion when there is a closed-loop communication error.
4. Touch the Up and Down arrows to scroll through the screens. Touch the checkmark button to save changes.
5. Exit and restart the inverter-charger.

NOTE

- If there is a break in communication between the LYNK II and inverter-charger for more than ten seconds, the inverter-charger will safely stop operation, so long as the **BMS Lithium** option is selected and the **BMS_Err_Stop** parameter is enabled on the NOARK inverter-charger. The inverter-charger will display an **F58 BMS Communication Fault** if communication is lost. The NOARK inverter-charger will check every five minutes and resume closed-loop operation if communication is re-established.
- If communication cannot be reestablished and you need to resume operation, you may have to manually convert the Noark inverter to an open-loop configuration. For instructions on configuring open loop, refer to [A.7.1 NOARK Inverter Configuration \(Open Loop\)](#).

NOTE

If using multiple inverter-chargers, configure NOARK inverter-chargers to operate in parallel before setting the battery operation parameters.

NOTE

Depending on your system and particular use case, there may be other settings that require configuration. Refer to the inverter manual for information on these settings.

Main Screen > System Setup > Battery Setting

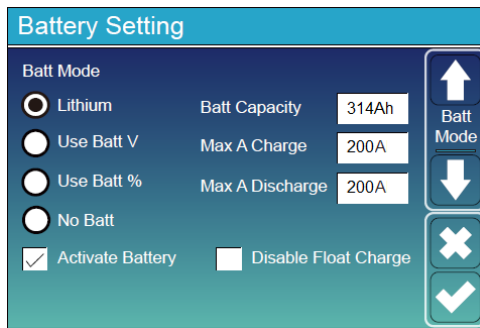

Figure 46. Battery Setting - Noark Closed-Loop Charge Settings

Battery Setting (page 1)	
Batt Mode	
Lithium ⁽¹⁾	Select the Lithium option to use the battery BMS.
Use Batt V	
Use Batt %	
No Battery	
Activate Battery	Select this check box.

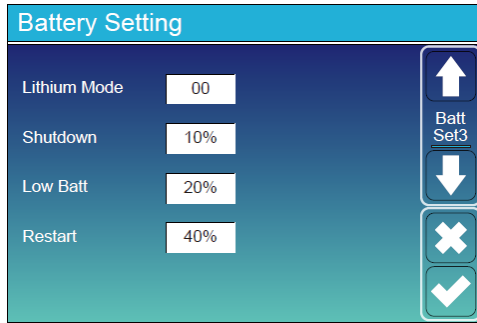

Figure 47. Battery Setting - Noark Closed-Loop Charge Settings

Battery Setting (page 3)	
Lithium Mode	Set this value to 00.
Shutdown	Adjust values to support the use case or keep the original open-loop values.
Low Batt	
Restart	

Main Screen > System Setup > Advanced Function

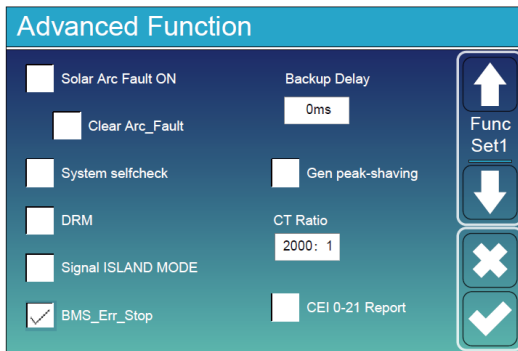

Figure 48. Advanced Function - Noark Closed-Loop Setting

Advanced Function	
BMS_Err_Stop	Select this check box to cause the inverter-charger to stop operating if there is a communication error.

A.7.1 NOARK Inverter Configuration (Open Loop)

If closed-loop communication cannot be established and you need to resume operation, you may have to manually convert the Noark inverter-charger to an open-loop configuration. Refer to the latest Discover Lithium battery documentation for battery values and the latest NOARK documentation for details on menu navigation and the setup procedure.

Specify the battery settings according to the instructions in the tables that follow.

NOTE

Depending on your system and particular use case, there may be other settings that require configuration. Refer to the inverter manual for information on these settings.

Open-Loop — Battery Setting

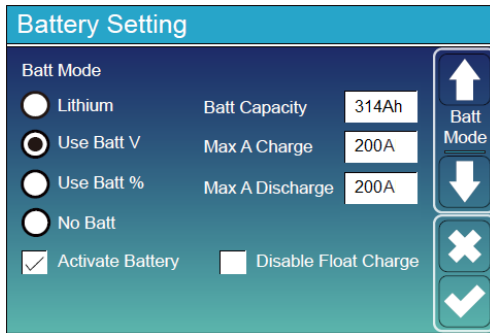

Figure 49. Battery Setting - Noark Open-Loop Charge Settings

Battery Setting (page 1)	
Batt Mode	
Lithium ⁽¹⁾ Use Batt V Use Batt % No Battery	Select the Use Batt V option to use battery voltage for all the settings.
Activate Battery	Select this check box.
Batt Capacity	Set to the number of Discover Lithium batteries x Ah capacity of each. For example, set to 628 Ah (2 x 314 Ah) for two HELIOS ESS 52-48-16000.

Battery Setting (page 1)	
Max A Charge	<p>For a single inverter, set to the lesser value between the inverter's maximum charge rate or the quantity of attached batteries multiplied by the battery's maximum charge rating.</p> <p>For example:</p> <p>Single phase system with Ex9N-DH-6KS-AU inverter and two HELIOS ESS 52-48-16000 batteries</p> <ul style="list-style-type: none"> • Set the Ex9N-DH-6KS-AU inverter to the lesser of the inverter's maximum charge rate of 135 A, or 400 A for two HELIOS ESS 52-48-16000 batteries that are each rated at a maximum charge rating of 200 A ($2 \times 200 \text{ A} = 400 \text{ A}$). <p>Three-phase system with three Ex9N-DH-6KT-AU inverters and two HELIOS ESS 52-48-16000 batteries</p> <ul style="list-style-type: none"> • For a three-phase system, set to the lesser value between the master inverter's maximum charge rate or the quantity of attached batteries multiplied by the battery's maximum charge rating divided by the number of inverters. For example, set the Ex9N-DH-6KT-AU inverter to the lesser of the inverter's maximum charge rate of 150 A, or 133 A for two HELIOS ESS 52-48-16000 batteries that are each rated at a maximum charge rate of 200 A, and then divided by three inverters ($2 \times 200 \text{ A} \div 3 = 133.33 \text{ A}$).
Max A Discharge	<p>For a single inverter, set to the lesser value between the inverter's maximum discharge rate or the quantity of attached batteries multiplied by the battery's maximum discharge rating.</p> <p>For example, set the Ex9N-DH-6KS-AU inverter to the lesser of the inverter's maximum discharge rate of 135 A, or 400 A for two HELIOS ESS 52-48-16000 batteries that are each rated at a maximum discharge rating of 200 A.</p> <p>For a three-phase system, set to the lesser value between the master inverter's maximum discharge rate or the quantity of attached batteries multiplied by the battery's maximum discharge rating divided by the number of inverters. For example, set the Ex9N-DH-6KT-AU inverter to the lesser of the inverter's maximum discharge rate of 150 A, or 133 A for two HELIOS ESS 52-48-16000 batteries that are each rated at a maximum discharge rate of 200 A and then divided by 3 inverters ($2 \times 200 \text{ A} \div 3 = 133.33 \text{ A}$).</p>

(1) To configure the open-loop parameters, do not select the Lithium parameter. Selecting the Lithium parameter enables the BMS for closed-loop communication.

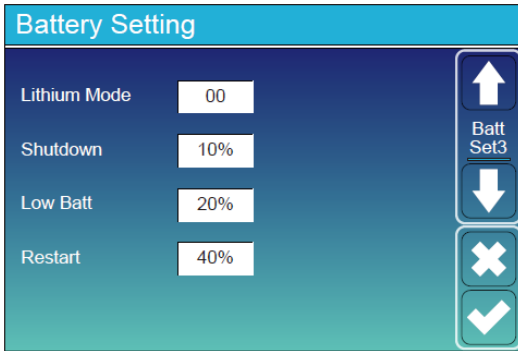

Figure 50. Battery Setting - Noark Inverter Shutdown/Restart Settings

Battery Setting (page 3)	
Lithium Mode	This property is not applicable in a open-loop configuration.
Shutdown	Turns off the inverter when the battery reaches this SOC.
Low Batt	Inverter outputs a warning when the battery reaches this SOC.
Restart	Inverter AC output continues when the battery reaches this SOC.

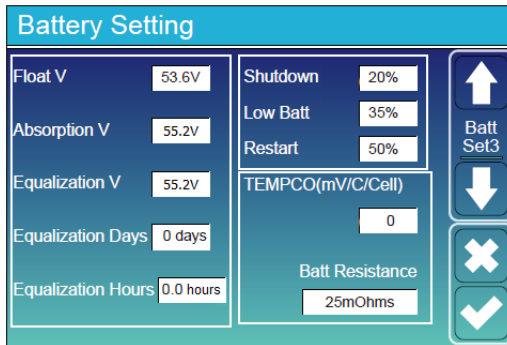

Figure 51. Battery Setting - Noark Open-loop Battery Settings

Battery Setting (page 3)	
Float V	53.6 V
Absorption V	55.2 V
Equalization V	Do not equalize Discover Lithium batteries
Equalization Days	
Equalization Hours	
Shutdown (%)	Turns off the inverter when the battery reaches the specified SOC.

Battery Setting (page 3)	
Low Batt (%)	Inverter outputs a warning when the battery reaches the specified SOC.
Restart (%)	Inverter AC output continues when the battery reaches the specified SOC.
TEMPCO (mv/C/Cell)	Set to 0 mv/C/Cell. ⁽¹⁾
Batt Resistance	Keep the default value of 25 mOhms.

(1) Discover Lithium batteries do not require temperature compensation. Setting TEMPCO to 0 mv/C/Cell disables inverter controlled temperature compensation.

NOTE

For more information about configuring the Noark inverter-charger, refer to product documentation on the Noark website (na.noark-electric.com) or the [LYNK II Noark User Manual \(805-0075\)](#).

A.8 Sol-Ark Inverter Configuration (Closed Loop Without LYNK II)

The HELIOS ESS supports closed-loop communication with the Sol-Ark inverters listed in [Table A-1, Closed-Loop Communication with Inverters](#).

To enable communication between the inverter and batteries:

1. When setting up closed-loop communication with:
 - 5K to 15K-P and 12K to 15K-2P outdoor inverters, connect a CAT6 or higher straight cable from the HELIOS ESS COM2 port to the CAN port of the Sol-Ark inverter-charger.

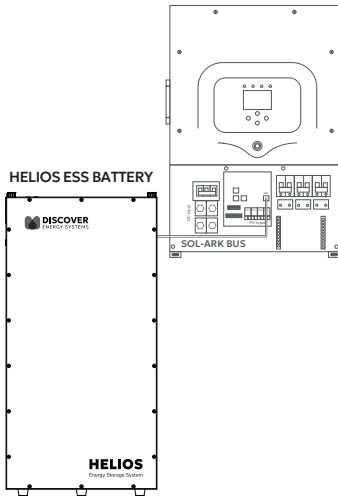

Figure 52. Sol-Ark Outdoor 5K-P / 8K-P / 12K-P / 15K-P

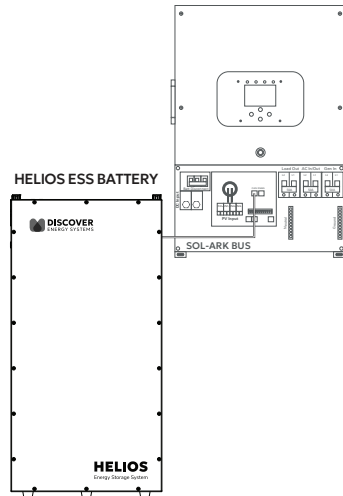

Figure 53. (Legacy) Indoor Sol-Ark 12K Hybrid

- (Legacy) 8K to 12K Hybrid Indoor inverters, create your own cable as identified in [A.3.1 Cables for Closed-Loop Communication Without LYNK II - Legacy Sol-Ark](#), and connect the cable from the HELIOS ESS COM2 port to the CAN port of the Sol-Ark inverter-charger.
2. Configure the Inverter-Charger
 - a. Using the touch screen and keypad on the inverter-charger, navigate to **System Setup > Batt Setup**.
 - b. Specify the settings according to the instructions in the tables that follow to stop power conversion when there is a closed-loop communication error.
 - c. Touch the Up and Down arrows to scroll through the screens. Touch the checkmark button to save changes.
 3. Exit and restart the inverter-charger.

NOTE

- If there is a break in communication between the HELIOS ESS battery and inverter-charger for more than ten seconds, the inverter-charger will safely stop operation, so long as the **BMS Lithium Batt** and the **BMS_Err_Stop** parameters are both enabled on the Sol-Ark inverter-charger. The inverter-charger will display an **F58 BMS Communication Fault** if communication is lost. The Sol-Ark inverter-charger will check every five minutes and resume closed-loop operation if communication is re-established.
- If communication cannot be reestablished and you need to resume operation, you may have to manually convert the Sol-Ark inverter to an open-loop configuration. For instructions on configuring open loop, refer to [A.8.1 Sol-Ark Inverter Configuration \(Open Loop\)](#).
- It is recommended that the Sol-Ark inverter be programmed with the appropriate open-loop settings before enabling closed-loop communication. Refer to [A.8.1 Sol-Ark Inverter Configuration \(Open Loop\)](#).

NOTE

Depending on your system and particular use case, there may be other settings that require configuration. Refer to the inverter manual for information on these settings.

System Setup > Batt Set^{UP} > Batt

Batt Setup			
Batt	Charge	Discharge	Smart Load
Batt Capacity	<input type="text" value="628 Ah"/>	<input type="checkbox"/>	Use Batt V Charged
Max A Charge	<input type="text" value="185 A"/>	<input checked="" type="checkbox"/>	Use Batt % Charged
Max A Discharge	<input type="text" value="185 A"/>	<input type="checkbox"/>	No Battery
TEMPCO	<input type="text" value="-0mV/C/Cell"/>	<input checked="" type="checkbox"/>	BMS Lithium Batt <input type="text" value="00"/>
		<input checked="" type="checkbox"/>	Activate Battery
<input type="button" value="CANCEL"/>		<input type="button" value="OK"/>	

Figure 54. Battery Setting - Sol-Ark Closed-loop Charge Settings

Batt Setup > Batt	
Batt Capacity	Set to the number of Discover Lithium batteries x Ah capacity of each. (eg. Set to 260 Ah for two AES batteries, each rated 130 Ah capacity).

Batt Setup > Batt	
Max A Charge	<p>For a single inverter, set to the lesser of the inverter's maximum charge rate or the quantity of attached batteries multiplied by the battery's maximum charge rating.</p> <p>For example:</p> <p>Single phase system with 12K-2P-N inverter and two HELIOS ESS 52-48-16000 batteries</p> <ul style="list-style-type: none"> • Set the 12K-2P-N inverter to the lesser of the inverter's maximum charge rate of 185 A, or 400 A for two HELIOS ESS 52-48-16000 batteries that are each rated at a maximum charge of 200 A ($2 \times 200 \text{ A} = 400 \text{ A}$). ⁽¹⁾ <p>Three-phase system with three Sol-Ark 15K-2P-N inverters and two HELIOS ESS 52-48-16000 batteries</p> <ul style="list-style-type: none"> • For a three phase system set to the lesser value between the master inverter's maximum charge rate or the master inverter, or the quantity of attached batteries multiplied by the battery's maximum charge rating divided by the number of inverters. For example, set the 12K-2P-N inverter to the lesser of the inverter's maximum charge rate of 185 A, or 133 A for two HELIOS ESS 52-48-16000 batteries that are each rated at a maximum charge of 200 A, and then divided by three inverters ($2 \times 200 \text{ A} \div 3 = 133.33 \text{ A}$).
Max A Discharge	<p>For a single inverter, set to the lesser value between the inverter's maximum discharge rate or the quantity of attached batteries multiplied by the battery's maximum discharge rating. For example, set the 12K-2P-N inverter to the lesser of the inverter's maximum discharge rate of 185 A, or 400 A for two HELIOS ESS 52-48-16000 batteries that are each rated at a maximum discharge rating of 200 A.</p> <p>For a three-phase system, set to the lesser value between the master inverter's maximum discharge rate or the quantity of attached batteries multiplied by the battery's maximum discharge rating divided by the number of inverters. For example, set the 12K-2P-N inverter to the lesser of the inverter's maximum discharge rate of 185 A, or 133 A for two HELIOS ESS 52-48-16000 batteries that are each rated at a maximum discharge rate of 200 A and then divided by 3 inverters ($2 \times 200 \text{ A} \div 3 = 133.33 \text{ A}$).</p>
TEMPCO	This field is disabled when the BMS Lithium Batt check box is selected.
Use Batt V Charged	Disable
Use Batt % Charged	Enable
BMS Lithium Batt	Enable and set the value to 00. ⁽²⁾
Activate Battery	Enable

(1) The recommended value for Max A Charge is 75% of the rated maximum charge current for the battery.

(2) Selecting the BMS Lithium Batt check box confirms closed-loop operation. The value 00 specifies the CANBus Battery mode.

System Setup > Batt Setup > Charge

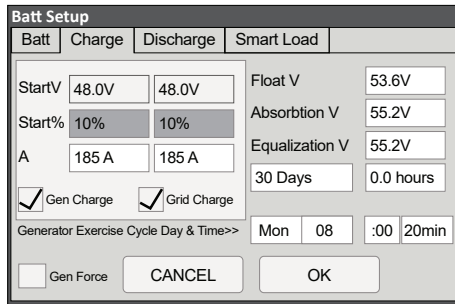

Figure 55. Battery Setting - Sol-Ark Closed-Loop Charge Settings

Batt Setup > Charge	
StartV	Unavailable (Grey) in a closed-loop configuration.
Start%	Set to user preference based on battery State-Of-Charge as a percentage. The recommended minimum is 10%.

System Setup > Batt Setup > Discharge

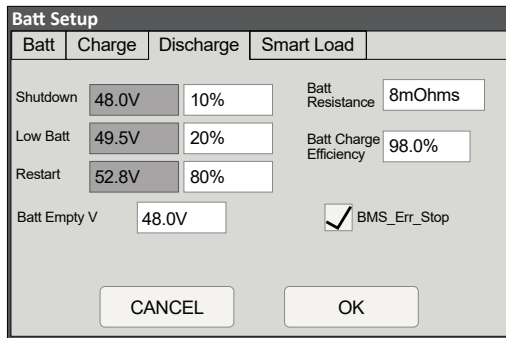

Figure 56. Advanced Function - Sol-Ark Closed-Loop Setting

Batt Setup > Discharge	
Shutdown	Adjust values to support the use case or keep the original values. (1)
Low Batt	
Restart	
Batt Empty V	48 V
Batt Resistance	Set to: 10 mOhm divided by the number of batteries (plus the mOhm value for cable resistance, if known). (2)
Batt Charge Efficiency	98%

Batt Setup > Discharge	
BMS_Err_Stop	Selecting this check box is recommended. A check mark causes the inverter-charger to stop operating if there is a communication error with the battery BMS.

- (1) A closed-loop configuration uses % state-of-charge. Voltage values are not configurable.
- (2) This value should include cable and connection resistance. The formula provided is to assist with the calculation of a general value.
- (3) BMS_Err_Stop MUST be enabled to cause the inverter to stop operating if there is a communication error. If BMS_Err_Stop is disabled, the inverter will continue to operate using the last communicated battery values.

A.8.1 Sol-Ark Inverter Configuration (Open Loop)

If closed-loop communication cannot be established and you need to resume operation, you may have to manually convert the Sol-Ark inverter to an open-loop configuration. Refer to the latest Discover Energy Systems documentation for battery values and the latest Sol-Ark documentation for menu navigation and details on the setup procedure.

NOTE
<ul style="list-style-type: none"> It is recommended that the Sol-Ark inverter be programmed with the appropriate open-loop settings before enabling closed-loop communication. Depending on your system and particular use case, there may be other settings that require configuration. Refer to the inverter manual for information on these settings.

1. Set the Discover Lithium batteries to ON and set the inverter-charger to ON.
2. Using the touch screen and keypad on the inverter, navigate to **System Setup > Battery Setup**.
3. Specify the battery settings according to the instructions in the tables that follow. Touch the Up and Down arrows to scroll through screens.
4. Touch the check mark button to save changes.
5. Exit and restart the inverter-charger.

Open Loop: System Setup > Battery Setup > Batt

Batt Setup

Batt	Charge	Discharge	Smart Load	
Batt Capacity	628 Ah	<input checked="" type="checkbox"/>	Use Batt V Charged	
Max A Charge	185 A	<input type="checkbox"/>	Use Batt % Charged	
Max A Discharge	185A	<input type="checkbox"/>	No Battery	
TEMPCO	-0mV/C/Cell	<input type="checkbox"/>	BMS Lithium Batt	00
			<input checked="" type="checkbox"/>	Activate Battery
CANCEL		OK		

Figure 57. Battery Setting - Sol-Ark Open-Loop Charge Settings

Battery Setup > Batt	
Batt Capacity	Set to the number of Discover Lithium batteries x Ah capacity of each. For example, set to 628 Ah (2 x 314 Ah) for two HELIOS ESS 52-48-16000 batteries.
Max A Charge	<p>For a single inverter, set to the lesser of the inverter's maximum charge rate or the quantity of attached batteries multiplied by the battery's maximum charge rating.</p> <p>For example:</p> <p>Single phase system with 12K-2P-N inverter and two HELIOS ESS 52-48-16000 batteries</p> <ul style="list-style-type: none"> • Set the 12K-2P-N inverter to the lesser of the inverter's maximum charge rate of 185 A, or 400 A for two HELIOS ESS 52-48-16000 batteries that are each rated at a maximum charge of 200 A (2 x 200 A = 400 A). ⁽¹⁾ <p>Three-phase system with three Sol-Ark 15K-2P-N inverters and two HELIOS ESS 52-48-16000 batteries</p> <ul style="list-style-type: none"> • For a three phase system set to the lesser value between the master inverter's maximum charge rate or the master inverter, or the quantity of attached batteries multiplied by the battery's maximum charge rating divided by the number of inverters. For example, set the 12K-2P-N inverter to the lesser of the inverter's maximum charge rate of 185 A, or 133 A for two HELIOS ESS 52-48-16000 batteries that are each rated at a maximum charge of 200 A, and then divided by three inverters (2 x 200 A ÷ 3 = 133.33 A).
Max A Discharge	<p>For a single inverter, set to the lesser value between the inverter's maximum discharge rate or the quantity of attached batteries multiplied by the battery's maximum discharge rating. For example, set the 12K-2P-N inverter to the lesser of the inverter's maximum discharge rate of 185 A, or 400 A for two HELIOS ESS 52-48-16000 batteries that are each rated at a maximum discharge rating of 200 A.</p> <p>For a three-phase system, set to the lesser value between the master inverter's maximum discharge rate or the quantity of attached batteries multiplied by the battery's maximum discharge rating divided by the number of inverters. For example, set the 12K-2P-N inverter to the lesser of the inverter's maximum discharge rate of 185 A, or 133 A for two HELIOS ESS 52-48-16000 batteries that are each rated at a maximum discharge rate of 200 A and then divided by 3 inverters (2 x 200 A ÷ 3 = 133.33 A).</p>
TEMPCO	Set to 0 mv/C/Cell Discover Lithium batteries do not require temperature compensation
Use Batt V Charged	Enable
Use Batt % Charged	Disable
BMS Lithium Batt	Disable
Activate Battery	Enable

Open Loop: System Setup > Battery Setup > Charge

Figure 58. Battery Setting - Sol-Ark Open-loop Battery Settings

Batt Setup > Charge	
StartV	Set to user preference based on battery voltage. The recommended minimum is 48 V.
Start%	Unavailable (Grey) in an open-loop configuration.
Float V	53.6 V
Absorption V	55.2 V
Equalization V	Do not equalize Discover Lithium batteries.
Equalization Days	
Equalization Hours	

Open Loop: System Setup > Battery Setup > Discharge

Figure 59. Battery Setting - Sol-Ark Open-loop Battery Settings

Batt Setup > Discharge	
Shutdown	Adjust values to support the use case or keep the original values.
Low Batt	
Restart	

Batt Setup > Discharge	
Batt Empty V	48 V
Batt Resistance	Set to: 10 mOhm divided by the number of batteries (plus the mOhm value for cable resistance, if known).
Batt Charge Efficiency	98%
BMS_Err_Stop	Clear this check box in an open-loop configuration.

NOTE

For more information about configuring the Sol-Ark inverter-charger, refer to product documentation on the Sol-Ark website (sol-ark.com) or the [LYNK II Sol-Ark User Manual \(805-0038\)](#).

A.9 Sunsynk Inverter Configuration (Closed Loop Without LYNK II)

The HELIOS ESS supports closed-loop communication with the Sunsynk inverters listed in [Table A-1, Closed-Loop Communication with Inverters](#).

To enable communication between the inverter and batteries:

1. Connect a CAT6 or higher straight cable from the HELIOS ESS COM2 port to the CAN port of the Sunsynk inverter-charger.

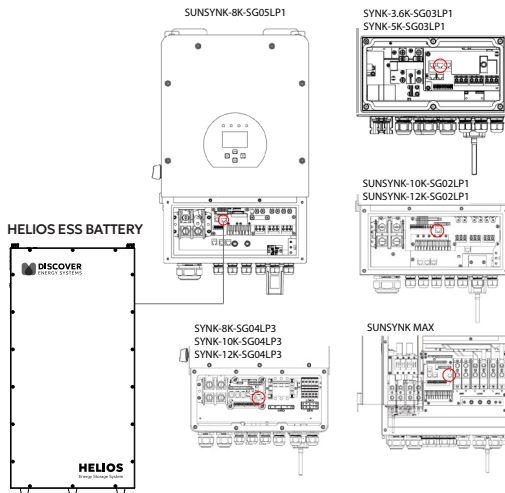

Figure 60. Sunsynk CAN Connection

2. Using the touch screen and keypad on the inverter-charger, navigate to **Main Screen > System Setup > Battery Setup**.
3. Configure the Inverter-Charger. Specify the battery settings according to the instructions in the tables that follow to stop power conversion when there is a closed-loop communication error.
4. Touch the Up and Down arrows to scroll through the screens. Touch the checkmark button to save changes.
5. Exit and restart the inverter-charger.

NOTE

- If there is a break in communication between the battery and inverter-charger for more than ten seconds, the inverter-charger will safely stop operation, so long as the **BMS Lithium** option is selected and the **BMS_Err_Stop** parameter is enabled on the Sunsynk inverter-charger. The inverter-charger will display an **F58 BMS Communication Fault** if communication is lost. The Sunsynk inverter-charger will check every five minutes and resume closed-loop operation if communication is re-established.
- If communication cannot be reestablished and you need to resume operation, you may have to manually convert the Noark inverter to an open-loop configuration. For instructions on configuring open loop, refer to [A.9.1 Sunsynk Inverter Configuration \(Open Loop\)](#).

NOTE

Depending on your system and particular use case, there may be other settings that require configuration. Refer to the inverter manual for information on these settings.

Closed Loop - Batt Type

Figure 61. Batt Type - Sunsynk Closed-Loop Settings

Batt type	
Batt type	Select the Lithium option to display Lithium battery associated settings.
Activate	Select this check box.
Batt Capacity	These settings are handled by the BMS.
Charge Amps	
Discharge Amps	
CAN RS485	Select the CAN option and specify 0 for the Protocol.
BMS_Err_Stop	Select this check box to cause the inverter-charger to stop operating if there is a communication error.

A.9.1 Sunsynk Inverter Configuration (Open Loop)

If closed-loop communication cannot be established and you need to resume operation, you may have to manually convert the Sunsynk inverter-charger to an open-loop configuration. Refer to the latest Discover Lithium battery documentation for battery values and the latest Sunsynk documentation for details on menu navigation and the setup procedure.

NOTE

Depending on your system and particular use case, there may be other settings that require configuration. Refer to the inverter manual for information on these settings.

1. Set the Discover Lithium batteries to ON and set the inverter-charger to ON.
2. Using the touch screen and keypad on the inverter-charger, navigate to **Main Screen > System Setup > Battery Setup**.
3. Specify the battery settings according to the instructions in the tables that follow.
4. Touch the **OK** button to save changes.
5. Exit and restart the inverter-charger.

NOTE

If using multiple inverter-chargers, configure SUNSYNK inverter-chargers to operate in parallel before setting the parameters for battery operation.

Open Loop – Batt Type

The SUNSYNK inverter-charger will operate in a open-loop configuration using voltage-based parameters if the BMS Lithium Batt parameter is disabled and the AGM V parameter is enabled.

Figure 62. Sunsynk Battery Setup for 2 x HELIOS ESS Batteries

Batt type	
Batt type	Select the AGM V option.
Activate	Select this check box.

Batt type	
Batt Capacity	Set to the number of Discover Lithium batteries x Ah capacity of each. For example, set to 628 Ah (2 x 314 Ah) for two HELIOS ESS 52-48-16000 batteries.
Charge Amps	<p>For a single inverter-charger, set to the lesser of the inverter-charger's maximum charge rate or the quantity of attached batteries multiplied by the battery's maximum charge rating.</p> <p>For example:</p> <p>Single phase system with 8K-SG05LP1 inverter-charger and two HELIOS ESS 52-48-16000 batteries:</p> <ul style="list-style-type: none"> Set the 8K-SG05LP1 inverter-charger to the lesser of the inverter-charger's maximum charge rate of 190 A, or 400 A for two HELIOS ESS 52-48-16000 batteries that are each rated at a maximum charge rating of 200 A ($2 \times 200 \text{ A} = 400 \text{ A}$).⁽²⁾ <p>Three-phase system with three 8K-SG04LP3 inverter-chargers and two HELIOS ESS 52-48-16000 batteries:</p> <ul style="list-style-type: none"> Set to the lesser value between the master inverter-charger's maximum charge rate and the quantity of attached batteries multiplied by the battery's maximum charge rate divided by the number of inverter-chargers. For example, set the 8K-SG04LP3 inverter-charger to the lesser of the inverter-charger's maximum charge rate of 190 A, or 133 A for two HELIOS ESS 52-48-16000 batteries that are each rated at a maximum charge rate of 200 A and then divided by three inverter chargers ($2 \times 200 \text{ A} \div 3 = 133.33 \text{ A}$).
Discharge Amps	<p>For a single inverter-charger, set to the lesser of the inverter-charger's maximum discharge rate or the quantity of attached batteries multiplied by the battery's maximum discharge rating.</p> <p>For example, set the 8K-SG05LP1 inverter-charger to the lesser of the inverter-charger's maximum discharge rate of 190 A, or 400 A for two HELIOS ESS 52-48-16000 batteries that are each rated at a maximum charge rating of 200 A ($2 \times 200 \text{ A} = 400 \text{ A}$).</p> <p>For a three-phase system with three inverter-chargers, set to the lesser value between the master inverter-charger's maximum discharge rate or the quantity of attached batteries multiplied by the battery's maximum discharge rate divided by the number of inverter-chargers. For example, set the 8K-SG04LP3 inverter-charger to the lesser of the inverter-charger's maximum discharge rate of 190 A, or 133 A for two HELIOS ESS 52-48-16000 batteries that are each rated at a maximum discharge rate of 200 A and then divided by 3 inverters ($2 \times 200 \text{ A} \div 3 = 133.33 \text{ A}$).</p>
TEMPCO	Set to 0 mV/C/Cell. ⁽³⁾

(1) Set Disable for the Lithium parameter to disable BMS communication. Additionally, open-loop communication requires clearing the BMS_Err_Stop check box in the Advanced Function screen.
Setting Enable for the Lithium parameter enables BMS communication and closed-loop communication with supported batteries.

(2) SUNSYNK's recommended maximum battery value for Charge Amps is 75% of the battery's rated maximum charge current.

(3) Discover Lithium batteries do not require temperature compensation. Setting TEMP_CO to 0 mV/C/Cell disables inverter-charger controlled temperature compensation.

Open Loop - Batt Charge

Figure 63. Sunsynk Battery Charge Settings

Batt charge	
Float V	Set the suggested voltage values defined in the associated battery manual.
Absorption V	
Equalization V	

Open Loop - Shutdown

Figure 64. Sunsynk Battery Shutdown Settings

Shut Down	
Shut Down	48 V
Low Batt	50 V
Restart	52 V

NOTE

For more information about configuring the Sunsynk inverter-charger, refer to product documentation on the Sunsynk website (www.sunsynk.org) or the [LYNK II SUNSYNK User Manual \(805-0075\)](#).

A.10 Victron Inverter Configuration (Closed Loop Without LYNK II)

The HELIOS ESS supports closed-loop communication with the Victron inverters listed in [Table A-1, Closed-Loop Communication with Inverters](#).

To enable communication between the inverter and batteries:

1. Connect a CAT6 or higher modified cable (refer to [Victron Energy](#)) from the HELIOS ESS COM2 port to the CAN port of the Victron GX device.

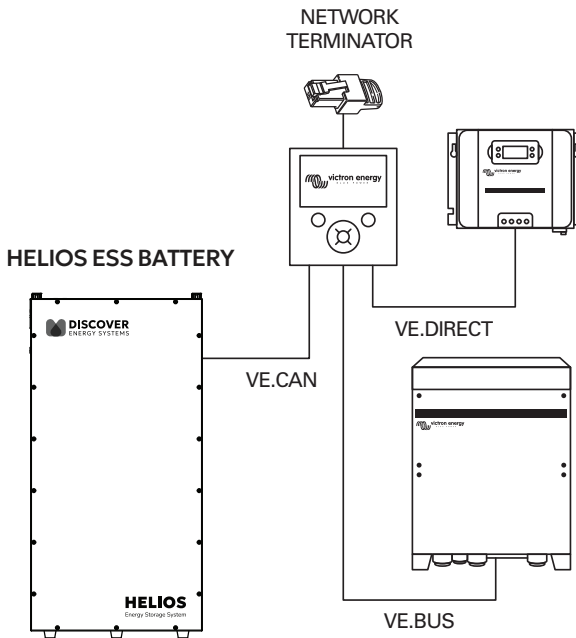

Figure 65. Victron CAN Connection

2. Using a touch screen or other user interface of the GX device, set the VE.Can port and CAN-Bus BMS communication rate to 500 kbit/s to match the communication speed on the HELIOS ESS battery.
3. **Device List > Settings > Services > VE.Can port > CAN-bus profile**
 - Select **CAN-bus BMS (500 kbit/s)**
4. Return to the Device List, and the Discover Lithium Battery should now appear as one of the devices.
5. During normal operation, the battery's charge parameter limits are set by the BMS and communicated by the Victron GX device to the inverter-charger and MPPT.
To optimize the performance of a Victron system, manually set the following DVCC menu items using the Victron GX device and reboot the system.

If communication is interrupted between the BMS and Victron inverter-charger, the Victron inverter-charger stops charging until communication is re-established.

Victron Closed-loop Configuration Procedure

Refer to the latest Discover Energy Systems documentation for battery values and the latest Victron documentation for menu navigation and details on the setup procedure.

1. Using a touch screen or other user interface of the GX device, set the VE.Can port and CAN-Bus BMS communication rate to 500 kbit/s to match the communication speed of the CAN port on the HELIOS ESS battery.

Device List > Settings > Services > VE.Can port > CAN-bus profile

- Select **CAN-bus BMS 500 kbit/s**.

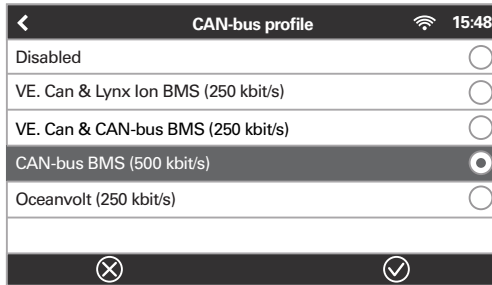

Figure 66. Victron CAN-bus Profile

2. Return to the Device List, and the Discover Lithium Battery should now appear as one of the devices.

Device List

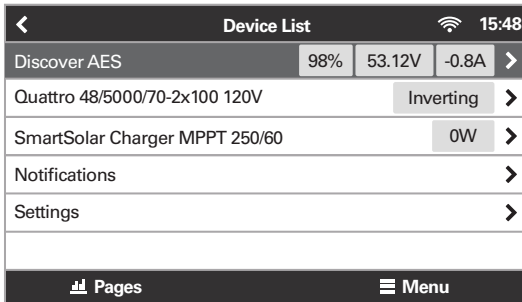

Figure 67. Victron Device List

NOTE

If Discover does not appear on the Device List:

- Confirm that the CAT6 or higher communication cable's communication lines are configured properly (refer to [Cables for Closed-Loop Communication Without LYNK II - Victron Energy](#)).
- Check the RJ45 connector for bad crimps or other connection issues.

- To confirm that all batteries in the network are communicating with the Victron system, review the actual battery parameters. If multiple batteries are connected, a single entry shows the total limit of all the batteries.

Device List > Discover AES > Parameters

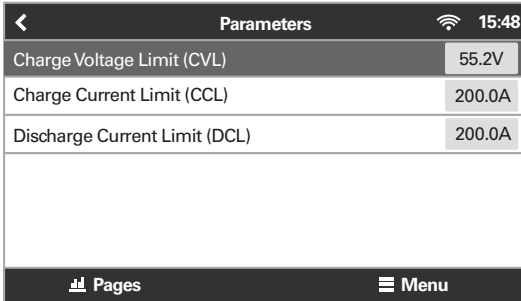

Figure 68. Victron Battery Parameters

Configurable Closed-Loop Settings

During normal operation, the battery’s charge parameter limits are set by the BMS and communicated by the Victron GX device to the inverter-charger and MPPT.

To optimize the performance of a Victron system, manually set the following DVCC menu items using the Victron GX device and reboot the system.

Device List > Settings > DVCC

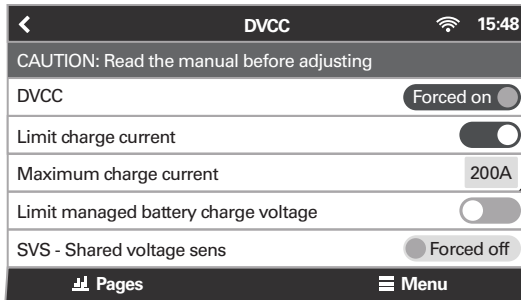

Figure 69. Victron DVCC Menus 1/2

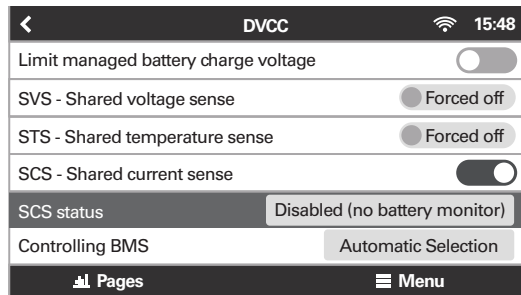

Figure 70. Victron DVCC Menus 2/2

DVCC Menu	Setting
DVCC (Distributed Voltage and Current Control)	Forced on
Limit charge current	ON ⁽¹⁾
Maximum charge current	Installed number of Discover Lithium batteries x their rated Maximum Charge current, or a lower value if system curtailment is required.
Limit managed battery charge voltage	Disable
SVS - Shared voltage sense	Forced off ⁽²⁾
STS - Shared temperature sense	Forced off
SCS - Shared current sense	ON
SCS status	(Displays the current status)
Controlling BMS	Automatic Selection

(1) Limit charge current works across the whole system. MPPTs are automatically prioritized over the mains. In cases where the BMS requests a maximum charge current different from the user-configurable setting, it uses the lesser of the two.

(2) SVS should be set to OFF (Victron support has reported instances of conflicts when SVS is set to ON with a Lithium BMS).

Saving the Configurable Closed-Loop Settings

After all DVCC menu items have been set, reboot the system to complete the closed-loop configuration.

Device List > Settings > General > Reboot?

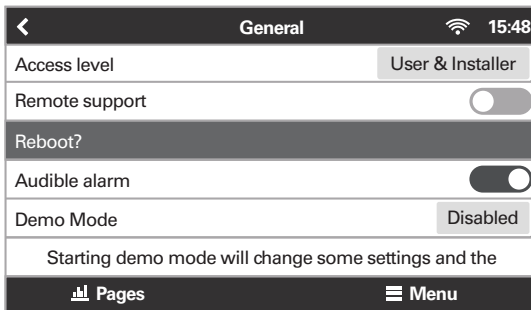

Figure 71. Victron Rebooting the System

NOTE

To avoid conflicting network information and data, do not use a Victron BMV battery monitor when using the LYNK II Communication Gateway.

A.10.1 Victron Inverter Configuration (Open Loop)

Whenever possible, using a closed-loop configuration is recommended with Discover batteries and Victron devices. However, using an open-loop configuration may be required if the closed-loop communication system encounters an issue.

If there is a break in communication between the Victron Energy device and the battery, the Victron device stops charging. Charging only resumes after communication between the Victron device and the HELIOS ESS battery is restored. If communication cannot be restored, you may have to set the system to open loop until an installation professional is available.

As a precautionary measure, it is recommended to program the inverter-charger with the correct voltage-based parameters before setting up the system to operate in a closed-loop configuration. If closed-loop communication fails, after the open loop parameters have been configured, turn the Victron device OFF and ON with the On/Off/Charger Only switch to enable the open-loop settings.

The following describes how to set up open loop on Victron devices.

Setting up Open Loop on Victron Devices

You will need the latest firmware on all connected devices. The following presumes familiarity with VE Configure software. After setting the voltage-based open-loop parameters using the VE Configure 3 software, 'send' all parameters to the inverter-charger and GX device and then restart the GX device.

NOTE

Depending on your system and particular use case, there may be other settings that require configuration. Refer to the inverter manual for information on these settings.

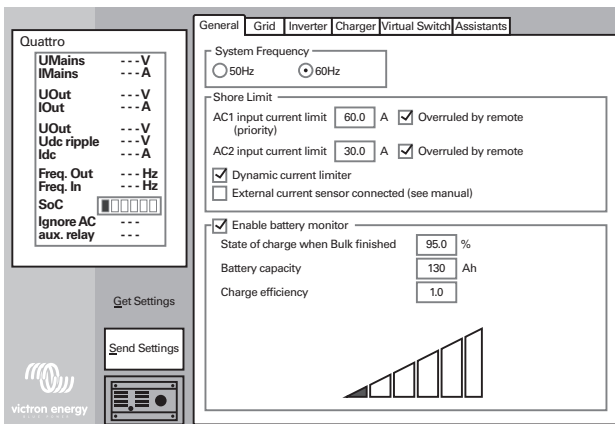

Figure 72. VE Configure 3 Software

Victron Inverter-Charger Open-loop Configuration Procedure

Refer to the latest Discover Energy Systems documentation for battery values and the latest Victron documentation for details on menu navigation and the setup procedure.

1. Set the Discover Lithium batteries to ON and set the inverter to ON.
2. Connect your computer to the Victron GX device or inverter.
3. On the computer, start the VE Configure 3 software configuration tool.
4. Enable and disable parameter values according to the tables below.
5. Send the parameters to the Victron inverter-charger and GX device.
6. Toggle the On/Off/Charger Only switch to turn the inverter OFF and ON.

VE Configure 3 > General Tab

General Tab	
[AC1] Overruled by remote ⁽¹⁾	Enable
[AC2] Overruled by remote ⁽¹⁾	Enable
Dynamic current limiter	Enable
External current sensor connected	Disable
Enable battery monitor	Enable
State of charge when Bulk finished ⁽²⁾	95%
Battery capacity	Number of batteries x 314 Ah
Charge efficiency ⁽²⁾	1.00

(1) Enable is recommended.

(2) Precautionary settings ignored during normal operation and communication with Discover lithium batteries.

VE Configure 3 > Inverter Tab

Inverter Tab	
DC input low shutdown ⁽¹⁾	48.0 V
DC input low restart ⁽²⁾	52.0 V
DC input low pre-alarm ⁽³⁾	49.5 V
Enable AES ⁽⁴⁾	Disable

(1) The lowest operating voltage allowed. Increase voltage as required.

(2) Restart voltage after DC input low shutdown. Recommend setting to the minimum value (minimum varies according to the DC Input low shutdown value).

(3) 49.5 V value (approximately 10% SOC) will trigger a low battery warning. Increase or decrease as Preferred.

(4) 'Enable AES' has no relation to the AES RACKMOUNT battery. Refer to Victron manuals for information on the AES setting and function.

VE Configure 3 > Charger Tab

Charger Tab	
Enable charger	Enable
Battery Type ⁽¹⁾	Blank
Lithium batteries ⁽¹⁾	Enable

Charger Tab	
Charge curve ⁽¹⁾	Select: Fixed
Absorption Voltage ⁽¹⁾	55.2 V
Float Voltage ⁽¹⁾	53.6 V
Charge Current	Installed x 200 A
Repeated absorption time ^{(1) (2)}	1.0 < 3.0 Hr
Repeated absorption interval ⁽¹⁾	7.0 Days
Absorption time ^{(1) (2)}	1.0 < 3.0 Hr

(1) Precautionary settings ignored during normal operation and communication with Discover lithium batteries.

(2) The recommended minimum is 1.0 hour. Multiple batteries may require a longer time to achieve a smooth completion of charge.

NOTE

Confirm the Float Voltage after installation of any Victron 'Assistants', and if necessary, set the Float Voltage back to 53.6 V.

NOTE

For more information about configuring Victron devices, refer to product documentation on the Victron website (victronenergy.com) or the [LYNK II Victron \(Solar\) User Manual \(805-0040\)](#).