

# Introduction



## Guardian – IoT Gateway Installation and Operation Manual

©2022 Fortress Power LLC. All rights reserved.

All information in this document is subject to copyright and other intellectual property rights of Fortress Power, LLC. and its licensors. This material may not be modified, reproduced or copied, in whole or in part, without the prior written permission of Fortress Power, LLC. and its licensors. Additional information is available upon request. All other trademarks contained in this document are the property of their respective owners and their use herein does not imply sponsorship or endorsement of their products or services. The unauthorized use of any trademark displayed in this document or on the product is strictly prohibited.

### Introduction

The Guardian hub is a monitoring and controls device for your Fortress eFlex and eVault MAX battery products. It uploads your Fortress batteries' data to the cloud over Wi-Fi so that you can view key information on your battery system in the Guardian companion app such as charged percentage, time till full charge, voltage, current, and more. The companion app allows for a smoother tech support experience by featuring a chat widget where you can contact support directly. Additionally, the app automatically tracks your Fortress battery warranties once they are connected to the Guardian hub.

# Material List

**120V AC Power supply: 120V AC -> DC 24V / 2A adapter (outer diameter 5.5 / inner diameter 2.5 )**



**48V DC power cable for backup power from battery (included power cable is pre-crimped with ring terminals for battery)**

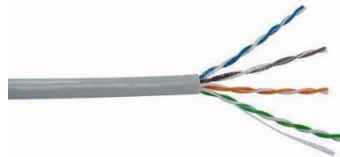

**Battery-Guardian Communication Cable**



Communication  
Cable

# Resetting the Hub

## Resetting the Guardian hub.

The Guardian has a reset button that can be pressed for 5 seconds to restore the Guardian to factory settings. Only use this function if directed by technical support. You can use the included pin to press the button.

## Physical Features

### Physical Features

- [IP23 Rated](#)
- Two power supply sources, one an AC/DC adapter wall socket, the other a DC input from your battery system.
- Connects to internet over home WI-FI connection or an ethernet cable
- CAN bus communication port for your Fortress battery products
- SD card input
- Reset Button
- Status Lights (details in physical specifications)

## Tools and Materials

### Materials and Tools Required

Original Guardian hub packaging does not include:

1. Din rail plate for din rail mounting bracket - to wall mount the Guardian please provide a short piece of din rail + appropriate wall fasteners. The Guardian includes a mounting bracket to attach to the din rail.

2. DC power cable. It can be fashioned by a black + red, #18 or #20 solid core wire pair with 3/8ths ring terminal.

**Please note that 3/8ths ring terminals compatible with small wire size are difficult to find and should be ordered in advance if planning to power from the batteries rather than an AC power source. Note 3/8ths is the trade size referring to the hole diameter. Actual hole diameter is 0.385 inch or 10-11 mm.**

# Specifications

## Specifications

### Electrical Specifications

Power Consumption	5W – 24V@1A power supply.
AC/DC Adapter	120V / 5A 24V DC 5.5mm
Supported Communication Types	1x MODBUS/TCP, 2x MOBUS/RTU, 2xCAN 2.0
Operation Frequency	2.4Ghz
Antennae	SMA standard connector
Environment	Indoor or inside a box
Local Communication	not yet available / 2023 eta

### Physical Specifications

Weight (device only)	0.8 lbs. – 0.4kg
Dimensions (device only) (W x H x D)	7.25 ‘’ x 6 ‘’ x 1.25 ‘’
Shipping package dimensions	Not known at this time
Shipping package weight	Not known at this time
Housing/	IP23 /
Mounting system	Din Rail Mount
Status Display LEDs	From top to bottom: power, cloud connection, Bluetooth or Wi-Fi connection, serial communication with battery, error signal

## Download the App

Commission the Fortress Guardian hub using the Fortress Power Guardian App.

Apple:

<https://apps.apple.com/us/app/fortress-power-guardian/id1632364415>

Google Playstore:

<https://play.google.com/store/apps/details?id=com.app.fortresspower>

# Wall or Din Mounting

The Guardian is din-rail mountable (such as within the FlexTower or DuraRack). You can mount the Guardian to a wall by mounting a short piece of din rail to the wall. Din rail is not included in the original Guardian packaging.



# Wiring the hub

Figure 1: Guardian Hub Connections

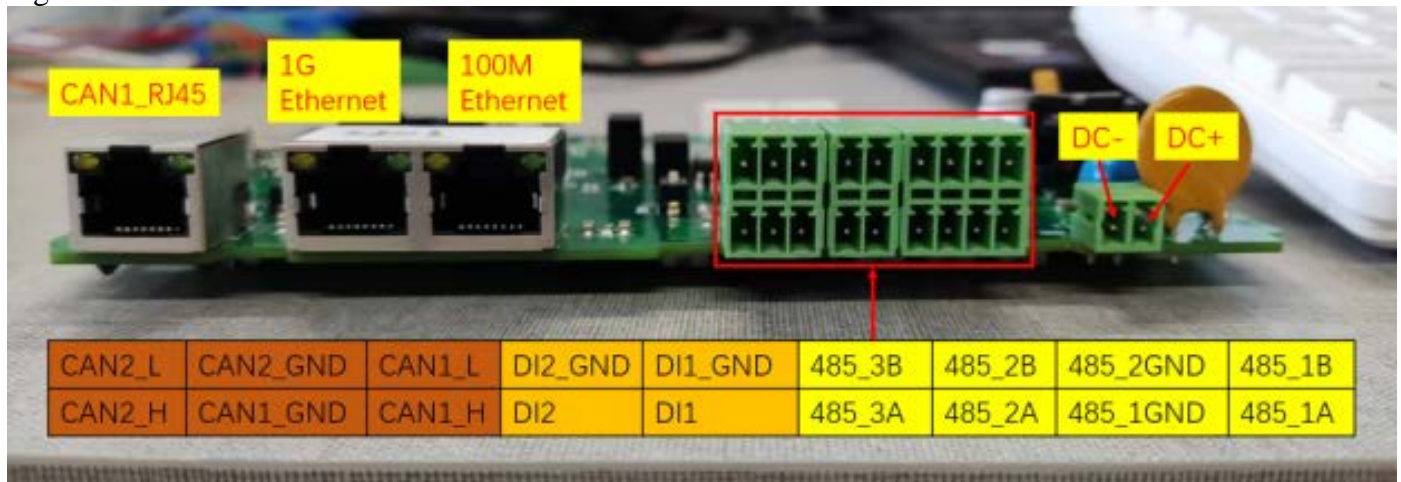

Initially, the Guardian will monitor both CAN1+CAN2 data streams. Eventually, it will only monitor the CAN2 data stream.

Each data stream has a high, low, and ground wire.

Use the charts below to identify the location of the CAN data streams.  
Plug an RJ45 ethernet cable into the Fortress battery, and the wire the appropriate ethernet communication wire into the appropriate port on the Guardian hub.

**eFlex:**

<b>Pin</b>	<b>Color (B format)</b>	<b>Assignment</b>
<b>1</b>	<b>White Orange</b>	<b>CAN1_H</b>
<b>2</b>	<b>Orange</b>	<b>CAN1_L</b>
<b>3</b>	<b>White Green</b>	<b>CAN1_ground</b>
<b>4</b>	<b>Blue</b>	<b>CAN2_H</b>
<b>5</b>	<b>White Blue</b>	<b>CAN2_L</b>
<b>6</b>	<b>Green</b>	<b>CAN2_ground</b>
<b>7</b>	<b>White Brown</b>	<b>RS485A (modbus)</b>
<b>8</b>	<b>Brown</b>	<b>RS485B (modbus)</b>

**eVault MAX:**

(not yet available)

# Commissioning

## Configuring the Guardian

A cell phone app is used (with Bluetooth) to set up Wi-fi access.  
Hardwired ethernet may also be used.

Please visit the Google Play store or Apple App store and search for the **Fortress Guardian App**.

- Login or Signup for the Guardian App by entering new account credentials or authenticating with a provider such as google or apple, and accept terms and conditions:

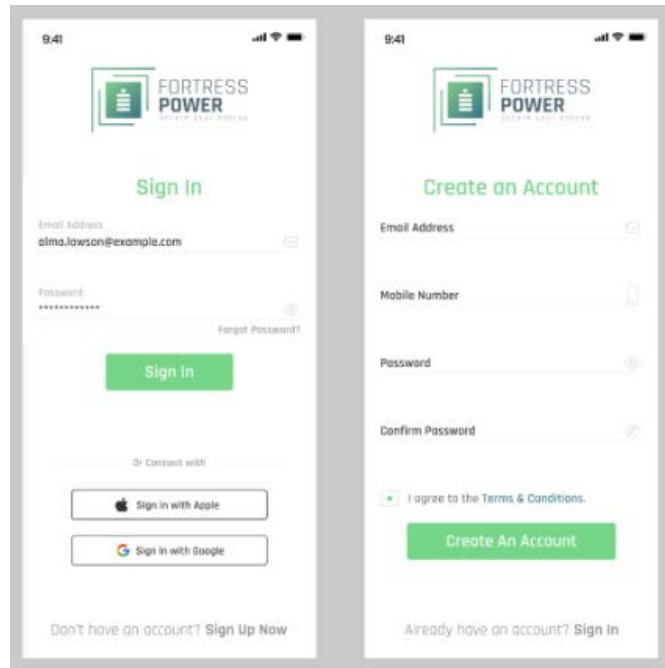

- Connect your phone to the Guardian hub over Bluetooth connection:

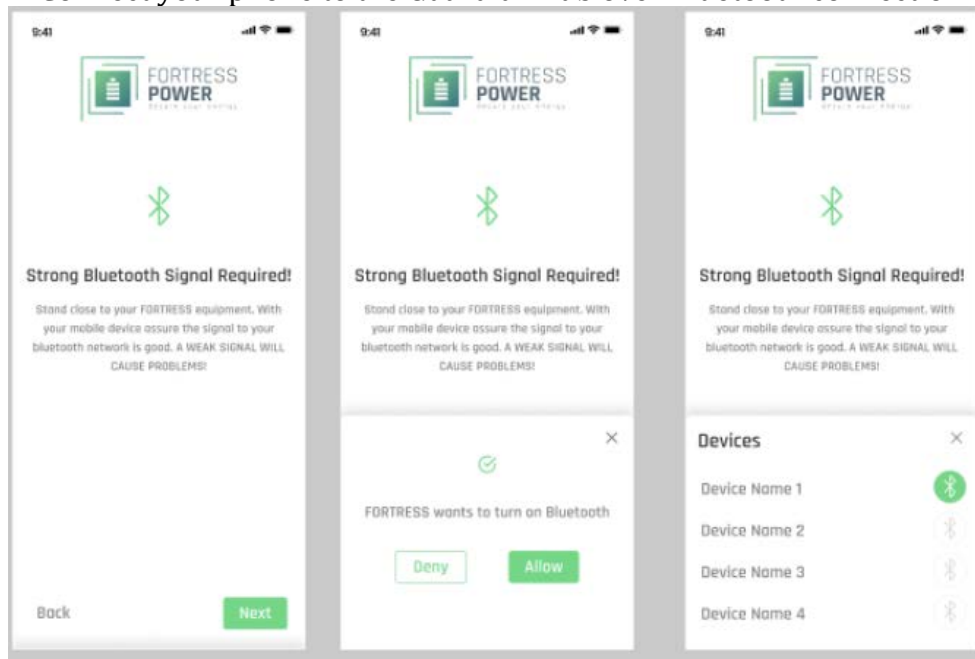

- Connect your Guardian hub to the internet over your home WI-FI:

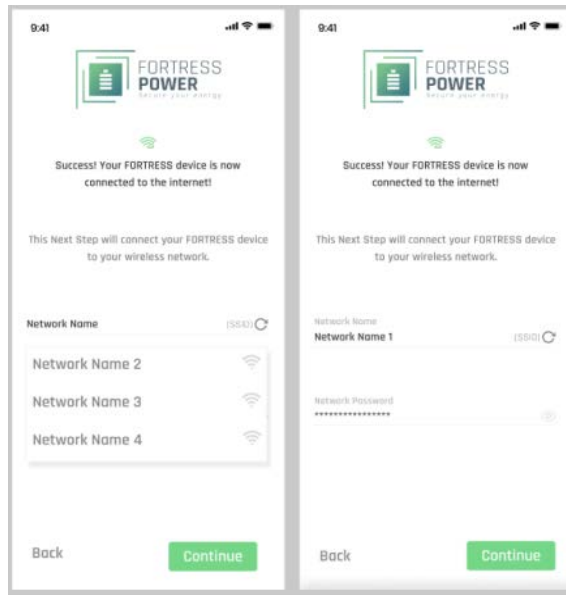

- Name your Fortress system and provide your address

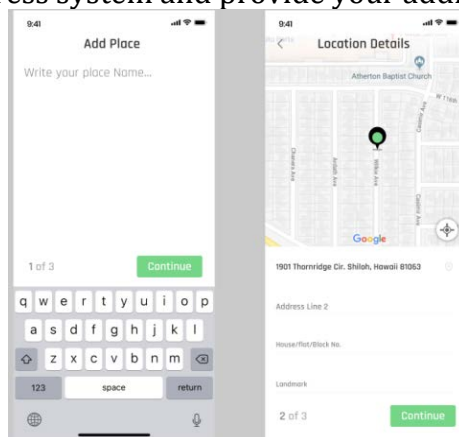

- Configure your Guardian Hub's information in the app. It should populate automatically:

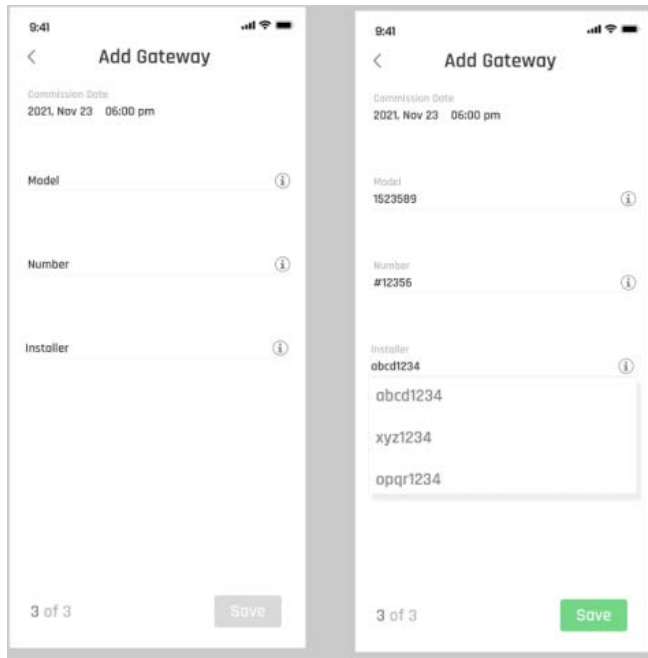

- Scan for batteries allowing the app to view information on your Fortress battery system's health from the Guardian hub:



- After submitting your battery information, you should now be able to see your newly created place. If you press on it, you will see a general overview of your battery system

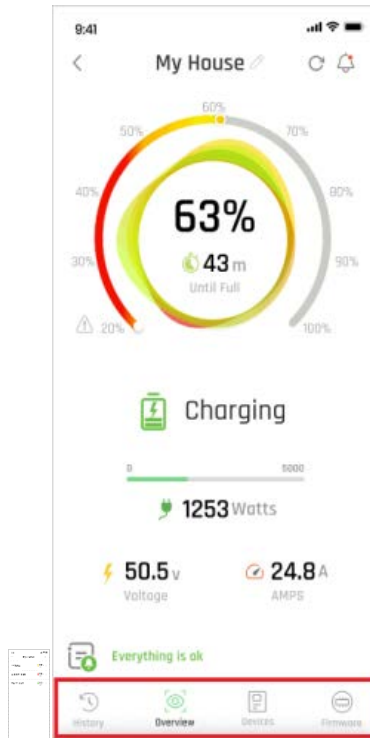

- Press any of the tabs highlighted in red above to get more information on your Fortress battery system:

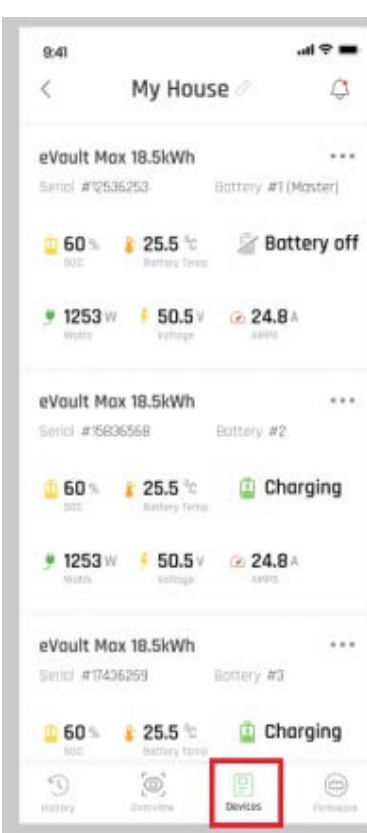
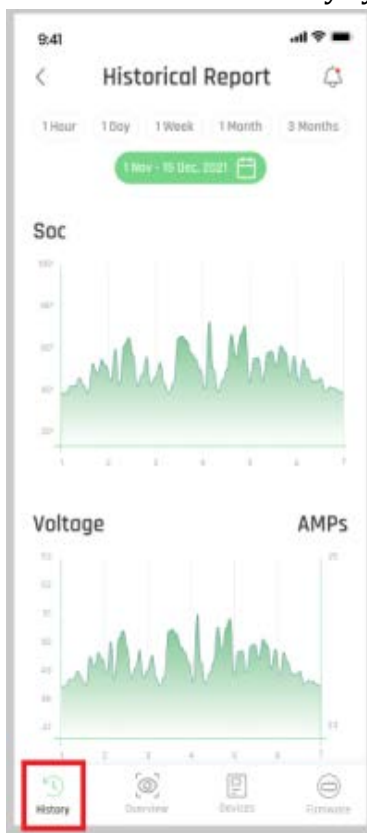

Changing Guardian Settings

- In the My Place section click on the dashboard icon in the top left to view the companion app dashboard:

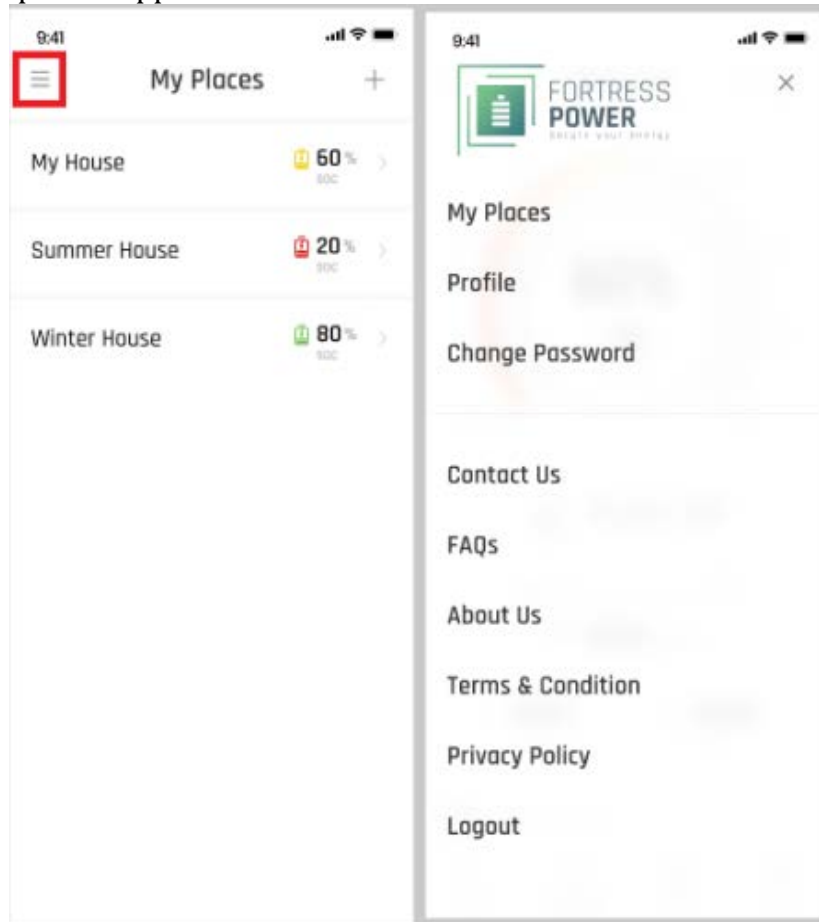

- Press on profile to update email and phone number information and on change password to update account password:

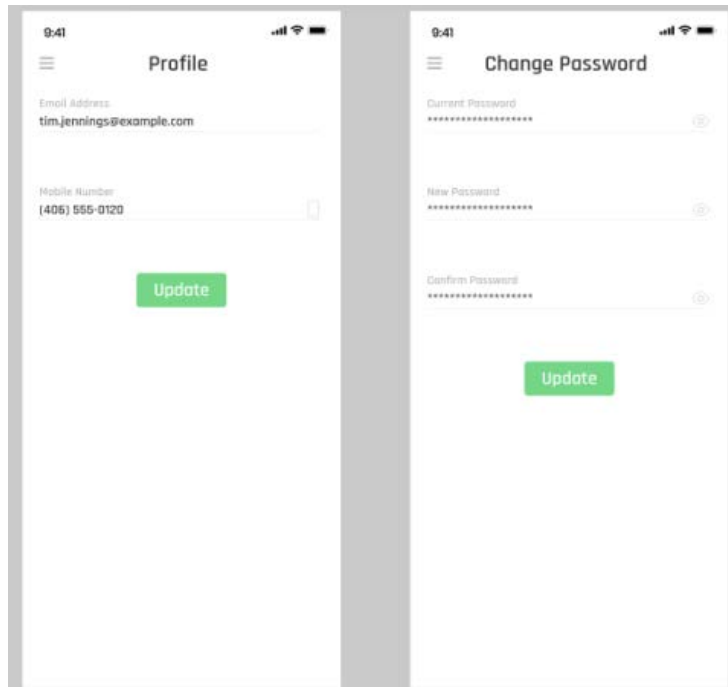

# Firmware

## Firmware Revision

The initial firmware version of the Guardian is 1.0.

Please check <https://fortresspower.com/firmware> for release information.

The Guardian is new hardware, so be prepared to update Guardian firmware at each site visit until ~2024.

## Upgrading Firmware

- Select the place where you want to update firmware then select firmware option from the icons below:

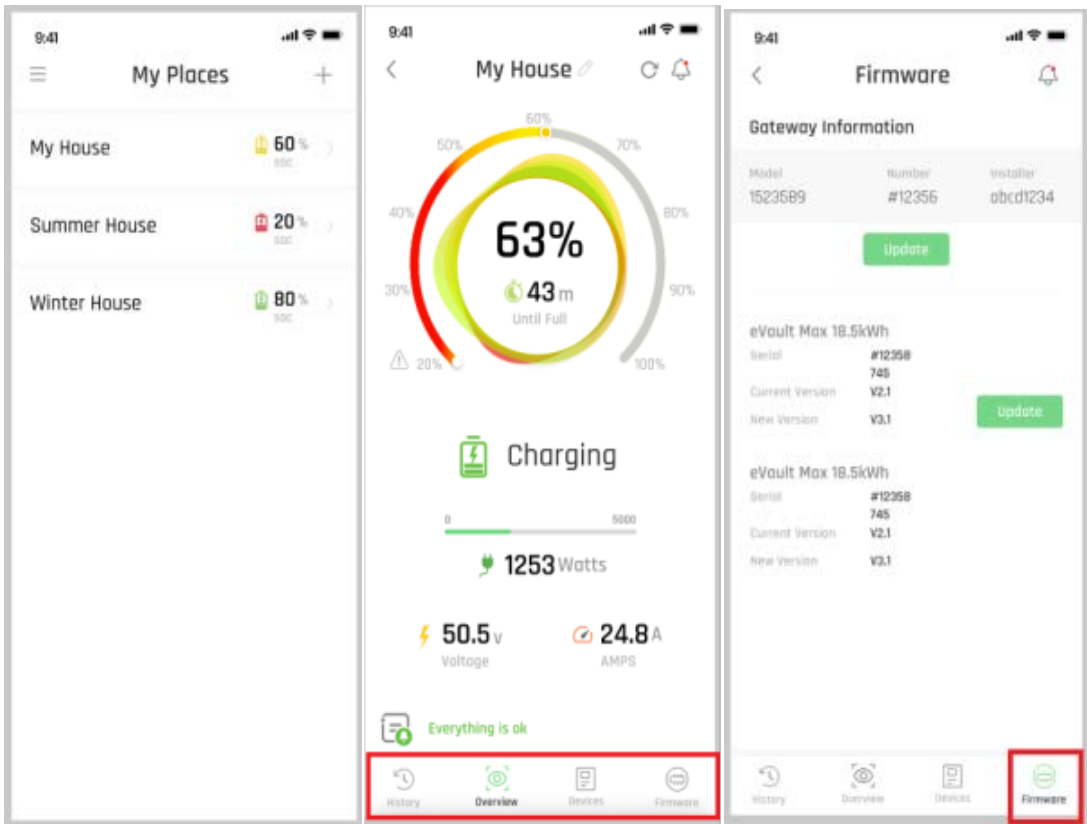

- Update the firmware of the Guardian hub by pressing the above update button or of the batteries that need it by pressing the update buttons below:

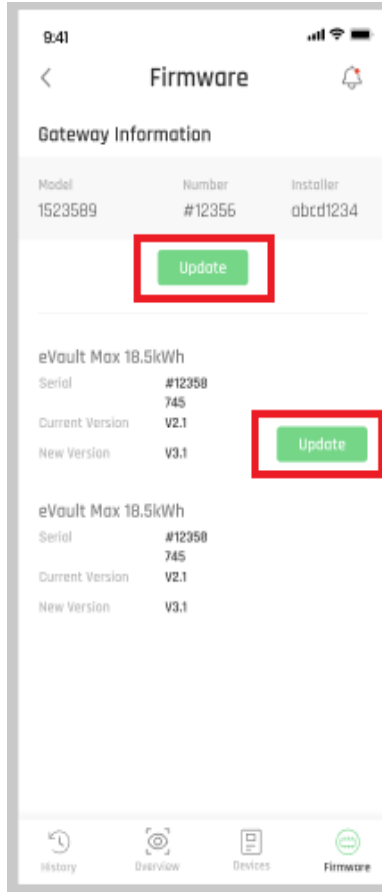

## Additional Information

### Troubleshooting

To troubleshoot Guardian issues, please fill out a support ticket at <https://support.fortresspower.com>

### Error Codes and Events

DISCONNECTED	1
INITIALIZING	2
CONNECTED	3
STANDBY	4
SOC PROTECTION	5
SUSPENDING	6
FAULT	99

- ChaSt (charge state)

OFF	1
EMPTY	2
DISCHARGING	3
CHARGING	4
FULL	5
HOLDING	6
TESTING	7

- Evt1 (faults)

COMMUNICATION_ERROR	0
OVER_TEMP_ALARM	1
OVER_TEMP_WARNING	2
UNDER_TEMP_ALARM	3
UNDER_TEMP_WARNING	4
OVER_CHARGE_CURRENT_ALARM	5
OVER_CHARGE_CURRENT_WARNING	6
OVER_DISCHARGE_CURRENT_ALARM	7
OVER_DISCHARGE_CURRENT_WARNING	8
OVER_VOLT_ALARM	9
OVER_VOLT_WARNING	10
UNDER_VOLT_ALARM	11
UNDER_VOLT_WARNING	12
UNDER_SOC_MIN_ALARM	13
UNDER_SOC_MIN_WARNING	14
OVER_SOC_MAX_ALARM	15
OVER_SOC_MAX_WARNING	16
VOLTAGE_IMBALANCE_WARNING	17
TEMPERATURE_IMBALANCE_ALARM	18
TEMPERATURE_IMBALANCE_WARNING	19
CONTACTOR_ERROR	20
FAN_ERROR	21
GROUND_FAULT	22
OPEN_DOOR_ERROR	23
CURRENT_IMBALANCE_WARNING	24
OTHER_ALARM	25
OTHER_WARNING	26
RESERVED_1	27
CONFIGURATION_ALARM	28
CONFIGURATION_WARNING	29

# Powering the Hub

The Guardian hub comes with a AC power supply wall wart.  
It may also be DC wired to a 48V power supply (i.e. Fortress batteries).  
Please see Tools and Materials section if planning to use the 48V power supply.

# Powering the Guardian

The Guardian includes options for 120V AC power, 48V DC power, or both simultaneously. Using both power supplies simultaneously allows for cell phone - Guardian communication even when the AC or DC power is unavailable.

Please note the AC power adapter converts to 24V - Do not connect battery power to the port intended for the AC wall wart.  
Use the 48V DC power port connector instead.

# Operation

## Alerts

- battery full
- battery empty