

TS4-X & TS4-A (725W) Platform of Flex MLPE Installation Manual



TS4-X Series



TS4-A (725W) Series

Visit the Tigo Energy [Help Center](#) for comprehensive videos, articles, and other resources for all Tigo products.

Disclaimer of Warranties and Limitation of Liability

The information, recommendations, descriptions, and safety disclosures in this document are based on Tigo Energy, Inc.'s ("Tigo") experience and judgment and may not cover all contingencies. If further information is required, consult a Tigo representative. Sale of the product shown in this document is subject to the terms and conditions outlined in Tigo's Limited Warranty, Terms and Conditions, and any other contractual agreements between Tigo and the purchaser.

THERE ARE NO UNDERSTANDINGS, AGREEMENTS, WARRANTIES, EXPRESSED OR IMPLIED, INCLUDING WARRANTIES OF FITNESS FOR A PARTICULAR PURPOSE OR MERCHANTABILITY, OTHER THAN THOSE SPECIFICALLY SET OUT IN ANY EXISTING CONTRACT BETWEEN THE PARTIES. ANY SUCH CONTRACT STATES THE ENTIRE OBLIGATION OF TIGO. THE CONTENTS OF THIS DOCUMENT SHALL NOT BECOME PART OF, OR MODIFY ANY CONTRACT BETWEEN, THE PARTIES.

In no event will Tigo be responsible to the purchaser or user in contract, in tort (including negligence), strict liability or otherwise for any special, indirect, incidental, exemplary, reliance or consequential damage or loss whatsoever, including but not limited to injury to persons, damage or loss of use of property, equipment or power systems, loss of profit, cost of capital, loss of power, additional expenses in the use of existing power facilities, or claims against the purchaser or user by its customers resulting from the use of the information, recommendations and descriptions contained herein. The information contained in this document is subject to change in Tigo's sole discretion and without notice.

Document Revision History

Version	Date	Changes
1.0	20241107	Initial Release
1.1	20251015	Change the connectors from TAP image. Added safety clarification on inverter behavior during TS4 rapid shutdown.

Contents



Disclaimer of Warranties and Limitation of Liability	2
Document Revision History	2
Contents	3
Overview – TS4-X.....	5
Overview – TS4 (725W).....	6
Outline.....	7
Important Safety Information	8
TS4-O/S Design.....	11
CCA Design Considerations	11
TAP Design Considerations.....	11
TAP Placement Requirements.....	12
TS4-X-O/S Install	13
TS4-A-O/S Install	14
To install a TS4-O/S	15
Install the CCA.....	17
Install Procedure.....	17
LED Status Indicators.....	18
Install the Tigo Access Point (TAP).....	19
Install Procedure.....	19
Commissioning.....	20
Create a New System	21
Enter Site Info	23
Select Equipment.....	25
Add Inverters & PV Modules.....	29
Configure Layout.....	32
TS4-F Design	38
RSS Transmitter Design Considerations.....	38
Large Commercial and Utility Site Considerations	39
Install RSS Transmitters.....	40
Install an Enclosure.....	41
RSS Transmitter Outdoor Kit for One Transmitter	41
RSS Transmitter Outdoor Kit for Two Transmitters.....	41

Connect Power Supplies.....	42
Connect a Core	45
Amplify a Signal with Two Cores	47
Connect Signal Wiring	48
Check Status LEDs	49
Post an RSS Label	49
Commissioning and Operations	49
Commissioning Checklist.....	49
Energize RSS Transmitters	50
De-Energize RSS Transmitters.....	50
Testing and Troubleshooting	51
Measurements Table Preparation.....	51
Unpowered String Measurements – Safety Voltage	52
Test Safety Voltages	52
Resolve Safety Voltage Errors	52
Powered String Measurements	53
Measure Open Circuit Voltage (V_{OC}).....	53
Resolve V_{OC} Errors	54
Test Current Direction	55
Resolve Current Direction Errors.....	56
Crosstalk Measurements	56
Test for Crosstalk.....	56
Resolve Crosstalk Problems	58
Resolve Transmitter Errors	58
RSS Signal Detection	59
Multi-factor Rapid Shutdown	60
MFRS System Design.....	60
Non-hybrid inverter systems	61
Hybrid Inverter Systems (DC-coupled energy storage systems).....	62
Specifications	63
Warranty	63
Support	63

Overview – TS4-X

Tigo TS4-X module level power electronics (MLPE) enable monitoring, rapid shutdown, and optimization of solar modules.



TS4-X has 3 models with different feature sets: TS4-X-O (Optimization, Monitoring, Rapid Shutdown), TS4-X-S (Monitoring and Rapid Shutdown), and TS4-X-F (Rapid Shutdown).

 <p>TS4-X-O</p> <p>Functions</p> <ul style="list-style-type: none"> • Optimization • Monitoring • Rapid Shutdown <p>Required</p> <ul style="list-style-type: none"> • CCA + TAP <p>Rating</p> <ul style="list-style-type: none"> • 800W, 25A (Isc), 20A (Imp) <p>Optional for added safety: MFRS (Multi-Factor Rapid Shutdown) RSS Transmitter</p>	 <p>TS4-X-S</p> <p>Functions</p> <ul style="list-style-type: none"> • Monitoring • Rapid Shutdown <p>Required</p> <ul style="list-style-type: none"> • CCA + TAP <p>Rating</p> <ul style="list-style-type: none"> • 800W, 25A (Isc), 20A (Imp) <p>Optional for added safety: MFRS (Multi-Factor Rapid Shutdown) RSS Transmitter</p>	 <p>TS4-X-F</p> <p>Functions</p> <ul style="list-style-type: none"> • Rapid Shutdown <p>Required</p> <ul style="list-style-type: none"> • RSS Transmitter <p>Rating</p> <ul style="list-style-type: none"> • 800W, 25A (Isc), 20A (Imp) <p>Optional: Upgrade to TS4-X-S</p>
---	---	--

Overview – TS4 (725W)

Tigo TS4 module level power electronics (MLPE) enable monitoring, rapid shutdown, and optimization of solar modules.

TS4 has 3 models with different feature sets: TS4-A-O (725W) (Optimization, Monitoring, Rapid Shutdown), TS4-A-S (725W) (Monitoring and Rapid Shutdown), and TS4-A-F (725W) (Rapid Shutdown).

 <p>TS4-A-O (725W)</p> <p>Functions</p> <ul style="list-style-type: none"> • Optimization • Monitoring • Rapid Shutdown <p>Required</p> <ul style="list-style-type: none"> • CCA + TAP <p>Rating</p> <ul style="list-style-type: none"> • 725W, 22A (Isc), 16A (Imp) <p>Optional for added safety: MFRS (Multi-Factor Rapid Shutdown) RSS Transmitter</p>	 <p>TS4-A-S (725W)</p> <p>Functions</p> <ul style="list-style-type: none"> • Monitoring • Rapid Shutdown <p>Required</p> <ul style="list-style-type: none"> • CCA + TAP <p>Rating</p> <ul style="list-style-type: none"> • 725W, 22A (Isc), 16A (Imp) <p>Optional for added safety: MFRS (Multi-Factor Rapid Shutdown) RSS Transmitter</p>	 <p>TS4-A-F (725W)</p> <p>Functions</p> <ul style="list-style-type: none"> • Rapid Shutdown <p>Required</p> <ul style="list-style-type: none"> • RSS Transmitter <p>Rating</p> <ul style="list-style-type: none"> • 725W, 22A (Isc), 16A (Imp) <p>Optional: Upgrade to TS4-A-S</p>
--	--	---

Outline

This manual is divided into three primary phases: **Design**, **Installation**, and **Commissioning**. Each phase contains specific instructions and guidelines for different products.

Section 1: [TS4-O/S – Design](#)

Section 2: [TS4-O/S – Installation](#)

Section 3: [TS4-O/S – Commissioning](#)

Section 4: [TS4-F – Design](#)

Section 5: [TS4-F – Installation & turning on](#)

Section 6: [Multi-factor Rapid Shutdown](#)

This structure should help in clearly presenting the information, making the manual easier to navigate and understand.

TAP and PLC Transmitter control power supply must be on same AC branch circuit to inverter to meet rapid shutdown requirement

Tigo equipment must be installed and maintained by licensed personnel in accordance with the National Electrical Code and ANSI/NFPA 70 wiring methods. In addition:

- Components must operate within the technical specifications listed in their [datasheets](#). Failure to follow instructions herein may cause equipment damage not covered by the warranty.
- Connectors from different manufacturers cannot be mated with each other.
- Installers must wear appropriate PPE and use insulated tools.
- This product could expose the user to chemicals known to the State of California to cause cancer. For more information refer to www.P65Warnings.ca.gov.

These safety symbols may appear in the manual:



A hazardous situation which could result in serious injury or loss of life.



A hazardous situation which could result in injury or damage to the product.

Important Safety Information



**LETHAL VOLTAGE MAY BE PRESENT IN ANY PV INSTALLATION
SAVE THESE INSTRUCTIONS**



WARNING - THIS PHOTOVOLTAIC RAPID SHUTDOWN EQUIPMENT (PVRSE) DOES NOT PERFORM ALL OF THE FUNCTIONS OF A COMPLETE PHOTOVOLTAIC RAPID SHUTDOWN SYSTEM (PVRSS). THIS PVRSE MUST BE INSTALLED WITH OTHER EQUIPMENT TO FORM A COMPLETE PVRSS THAT MEETS THE REQUIREMENTS OF NEC (NFPA 70) SECTION 690.12 FOR CONTROLLED CONDUCTORS OUTSIDE THE ARRAY. OTHER EQUIPMENT INSTALLED IN OR ON THIS PV SYSTEM MAY ADVERSELY AFFECT THE OPERATION OF THE PVRSS. IT IS THE RESPONSIBILITY OF THE INSTALLER TO ENSURE THAT THE COMPLETED PV SYSTEM MEETS THE RAPID SHUTDOWN FUNCTIONAL REQUIREMENTS. THIS EQUIPMENT MUST BE INSTALLED ACCORDING TO THE MANUFACTURER'S INSTALLATION INSTRUCTIONS.

This manual contains important instructions for installation and maintenance of the Tigo product models; TS4-X-O, TS4-X-S, TS4-X-F, TS4-A-O (725W), TS4-A-S (725W), TS4-A-F (725W), TAP (Tigo Access Point) and RSS Transmitter.



Risk of electric shock: do not remove cover, disassemble, or repair. There are no user serviceable parts inside. Refer to qualified service personnel.



Before installing or using the Tigo System, please read all instructions and warning markings on the Tigo products, appropriate sections of your inverter manual, photovoltaic (PV) module installation manual, and other available safety guides.



All equipment shall be installed and operated in an environment within the ratings and limitations of the equipment as published in the installation manual.



To reduce risk of fire and shock hazard, install this device with strict adherence to National Electric Code (NEC) ANSI/NFPA 70 and/or local electrical codes. When the photovoltaic array is exposed to light, it supplies a DC voltage to the Tigo TS4 units and the output voltage may be as high as the PV module open circuit voltage (V_{oc}) when connected to the module. The installer should use the same caution when handling electrical cables from a PV module with or without the TS4 units attached.



Use caution when connecting the units to the modules. **TS4 units ship ON by default, so module voltage is present once connected.** The PV array stays energized until all rapid shutdown devices (CCA and/or RSS Transmitters) are turned OFF. When using TS4-X or TS4-A (725 W) with third-party inverters that include integrated RSS transmitters, be aware that array voltage may remain live even if the CCA is powered down—creating potential shock hazards. To learn more about MFRS (Multi Factor Rapid Shutdown) [here](#).



Installation must be performed by trained professionals only. Tigo does not assume liability for loss or damage resulting from improper handling, installation, or misuse of products.



Remove all metallic jewelry prior to installing the Tigo TS4 units to reduce the risk of contacting live circuitry. Do not attempt to install in inclement weather.



Do not operate the Tigo TS4 units if they have been physically damaged. Check existing cables and connectors, ensuring they are in good condition and appropriate in rating. Do not operate Tigo TS4 units with damaged or substandard wiring or connectors. Tigo TS4 units must be mounted on the high end of the PV module backsheet or racking system, and in any case above ground.



Do not connect or disconnect underload. Turning off the inverter and/or the Tigo products may not reduce this risk. Internal capacitors within the inverter can remain charged for several minutes after disconnecting all power sources. Verify capacitors have discharged by measuring voltage across inverter terminals prior to disconnecting wiring if service is required. Wait 30 seconds after rapid shutdown activation before disconnecting DC cables or turning off DC disconnect.



Connectors from different manufacturers cannot be mated with each other.



The transmitter control power supply MUST be on the same AC branch circuit as the inverter to meet rapid shutdown requirements.



CONSIGNES DE SÉCURITÉ IMPORTANTES

**UNE TENSION MORTELLE PEUT ÊTRE PRÉSENTE
DANS TOUTE INSTALLATION PV**



Risque de choc électrique, ne retirez pas le couvercle, ne démontez pas et ne réparez pas, aucune pièce réparable par l'utilisateur à l'intérieur. Confiez l'entretien à du personnel d'entretien qualifié.



Avant d'installer ou d'utiliser le système Tigo, veuillez lire toutes les instructions et les avertissements sur les produits Tigo, les sections appropriées du manuel de votre onduleur, le manuel d'installation du module photovoltaïque (PV) et les autres guides de sécurité disponibles.



Tout l'équipement doit être installé et utilisé dans un environnement respectant les valeurs nominales et les limites de l'équipement telles que publiées dans le manuel d'installation.



Pour réduire les risques d'incendie et d'électrocution, installez cet appareil en respectant strictement le Code national de l'électricité (NEC) ANSI/NFPA 70 et/ou les codes électriques locaux. Lorsque le générateur photovoltaïque est exposé à la lumière, il fournit une tension continue aux unités Tigo TS4 et la tension de sortie peut être aussi élevée que la tension de circuit ouvert (V_{OC}) du module PV lorsqu'il est connecté au module. L'installateur doit faire preuve de la même prudence lors de la manipulation des câbles électriques d'un module PV avec ou sans les unités TS4 attachées.



Utilisez la plus grande prudence lors de la connexion des unités aux modules. Les unités TS4 sont **expédiées activées par défaut (ON)**, donc une tension de module est présente dès la connexion. Le champ photovoltaïque reste sous tension jusqu'à ce que tous les dispositifs d'arrêt rapide (CCA et/ou émetteurs RSS) soient éteints.

Lorsque vous utilisez les TS4-X ou TS4-A (725 W) avec des onduleurs tiers intégrant des émetteurs RSS, sachez que la tension du champ peut rester active même si le CCA est hors tension, créant ainsi un risque de choc électrique.

Pour en savoir plus sur le MFRS (arrêt rapide multifactoriel), [cliquez ici](#).



L'installation doit être effectuée uniquement par des professionnels qualifiés. Tigo n'assume aucune responsabilité pour les pertes ou dommages résultant d'une mauvaise manipulation, installation ou mauvaise utilisation des produits.



Retirez tous les bijoux métalliques avant d'installer les unités Tigo TS4 pour réduire le risque de contact avec les circuits sous tension. N'essayez pas d'installer par mauvais temps.



N'utilisez pas les TS4 endommagés ou mal câblés. Vérifiez câbles et connecteurs. Montez les unités en haut du module ou du système, toujours au-dessus du sol.



Ne pas connecter ou déconnecter sous charge. L'arrêt de l'onduleur et/ou des produits Tigo peut ne pas réduire ce risque. Les condensateurs internes de l'onduleur peuvent rester chargés pendant plusieurs minutes après avoir déconnecté toutes les sources d'alimentation. Vérifiez que les condensateurs se sont déchargés en mesurant la tension aux bornes de l'onduleur avant de déconnecter le câblage si un entretien est nécessaire. Attendez 30 secondes après l'activation de l'arrêt rapide avant de débrancher les câbles CC ou de désactiver la déconnexion CC.



Les connecteurs homologues de différents fabricants ne peuvent pas être accouplés les uns aux autres.



L'alimentation de commande de l'émetteur DOIT être sur le même circuit de dérivation CA que l'onduleur pour répondre aux exigences d'arrêt rapide.

CONSERVEZ CES INSTRUCTIONS

AVERTISSEMENT - CET ÉQUIPEMENT D'ARRÊT RAPIDE PHOTOVOLTAÏQUE (PVRSE) N'EXÉCUTE PAS TOUTES LES FONCTIONS D'UN SYSTÈME D'ARRÊT RAPIDE PHOTOVOLTAÏQUE COMPLET (PVRSS). CE PVRSE DOIT ÊTRE INSTALLÉ AVEC D'AUTRES ÉQUIPEMENTS POUR FORMER UN PVRSS COMPLET QUI RÉPOND AUX EXIGENCES DE LA SECTION 690.12 DE NEC (NFPA 70) POUR LES CONDUCTEURS CONTRÔLÉS EN DEHORS DU SYSTÈME. D'AUTRES ÉQUIPEMENTS INSTALLÉS DANS OU SUR CE SYSTÈME PV PEUVENT AFFECTER LE FONCTIONNEMENT DU PVRSS. IL EST DE LA RESPONSABILITÉ DE L'INSTALLATEUR DE S'ASSURER QUE LE SYSTÈME PV TERMINÉ RÉPOND AUX EXIGENCES FONCTIONNELLES D'ARRÊT RAPIDE. CET ÉQUIPEMENT DOIT ÊTRE INSTALLÉ SELON LES INSTRUCTIONS D'INSTALLATION DU FABRICANT.

Ce manuel contient des instructions importantes pour l'installation et la maintenance des modèles de produits Tigo ; TS4-X-O, TS4-X-S, TS4-X-F, TS4-A-O (725W), TS4 A-S (725W), TS4-A-F (725W), TAP (Tigo Access Point) et émetteur RSS.

TS4-O/S Design

CCA Design Considerations

A complete Tigo TS4-O/S system consists of three components: the TS4 unit, a Tigo Access Point (TAP), and a Cloud Connect Advanced (CCA). For monitoring, the TAP must be connected to the CCA, which requires an internet connection. This setup is necessary for system monitoring, warranty eligibility, and code compliance.

A CCA should control all TS4-O and TS4-S on all strings connected to a specific inverter or MPPT. Install the CCA near this inverter with access to AC power and the internet. Ethernet and Wi-Fi are built in.

- For PV RSS compliance, the CCA must be on the same AC branch circuit as the inverter(s) it is controlling. The rapid shutdown initiator, whether it is an automatic disconnect or a manual switch, must turn off power to the CCA.
- One CCA can communicate with up to 7 TAPs and up to 900 TS4s.
- Make all connections to TAPs before powering on the CCA.
- For systems with 2 TAPs or fewer, the DC power supply may be a Tigo power supply, or a 3rd-party power supply with 12-24V DC, 1A output.
- For systems with 3 TAPs or more, the DC power supply must be a 24V DC, 1A output.

A CCA also includes two three-pin RS-485 connections to enable up to 32 Modbus devices such as inverters, charge controllers, revenue-grade meters, and weather monitoring.

TAP Design Considerations

The TAP communicates wirelessly to the TS4s. Each TS4 in the system acts as a signal repeater to neighboring TS4s to further extend the wireless reach. This is called a mesh network.

There are distance criteria to ensure strong signal hopping in the mesh network. Failure to adhere to these design criteria can cause abnormal system behavior.

If you have any questions about TAP placement, please contact Tigo Support.

One TAP can communicate with up to 300 TS4s when placement guidelines are followed. A CCA can communicate with up to seven TAPs and up to 900 TS4s.

- The TAP must be within 10m/33ft of the TS4-4s within 10m/33ft.

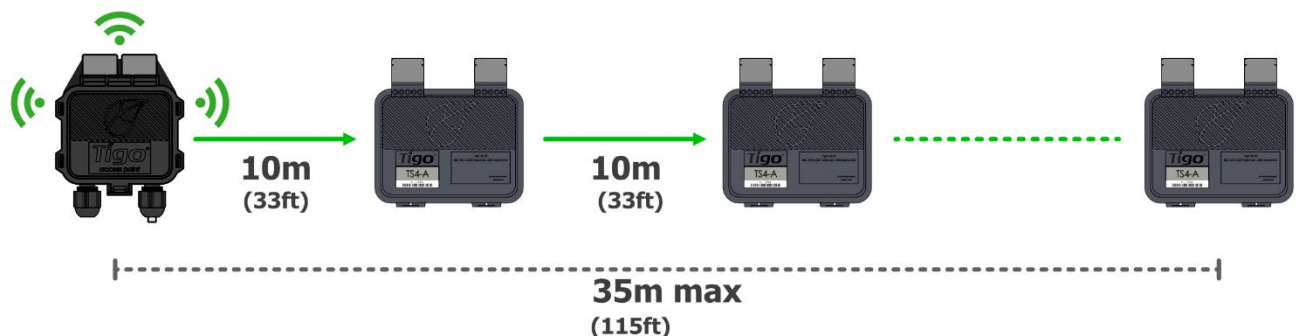

- Each TS4s can relay data to and from another TS4s within 10m/33ft. If your array has gaps between strings greater than 10m/33ft, then another TAP must be placed in that section of the array.
- The distance from the TAP to the farthest TS4s in its network is 35m/115ft. Exceeding this distance will require another TAP.

Install the TAP in the center of the array for the best coverage.

Ensure there are no obstructions that may interfere with the TAP signal to other TS4s units in the array. If the array has multiple roof planes, you may need to install multiple TAPs

TAP Placement Requirements

With mesh, the TS4s automatically act as repeaters, relaying messages when required. For the signal to hop on another TS4, the TS4s must **not be more than 10m (33ft) apart**.

If there is a gap between arrays of modules, ensure the distance is within the 10-meter limit.

The maximum range of a TAP, combined with multiple repeater hops, is a **maximum of 115ft / 35m**. If modules are located farther from the TAP or there are physical obstructions in the array (HVAC units, gables, parapets, drop-roofs, dormers, etc.), you may be required to use additional TAPs

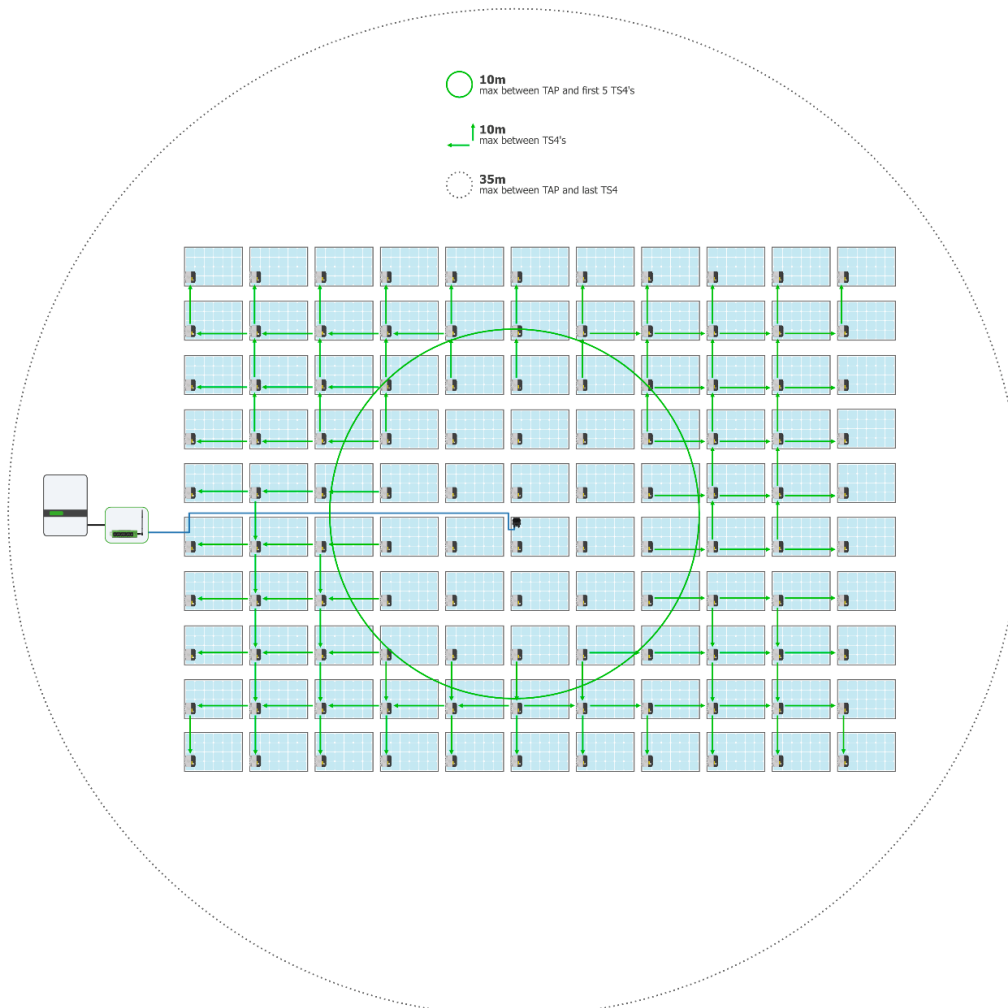

TS4-X-O/S Install



- Do not install TS4s if they have been physically damaged or with damage or substandard wiring or connectors.
- Do not connect or disconnect TS4s underload.

The TS4 module has 2 clip options to meet spacing requirements. When connecting the TS4 to the module frame, ensure that the space between the module glass is 12.7 mm (0.5 in) and TS4 label faces away from the glass.

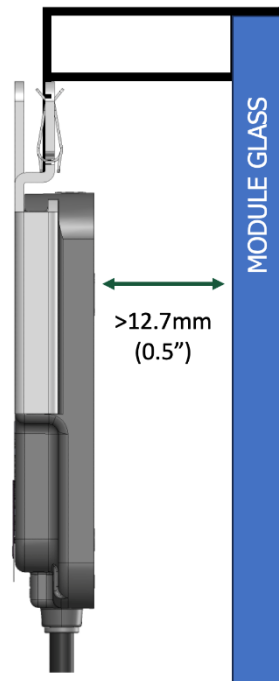

If using frameless modules, bolt the TS4 directly to the PV rail with M8 bolts and torque to 10.2Nm. No additional grounding is required.



TS4-A-O/S Install



- Do not install TS4s if they have been physically damaged or with damage or substandard wiring or connectors.
- Do not connect or disconnect TS4s underload.
- Do not apply an external voltage source to a module or string equipped with TS4s.

TS4s mount directly onto module frames with spring clips where the frame edge extends. If the TS4 is less than 12.7 mm (.5 in.) from the solar module glass, flip the TS4 so that the label faces the module.

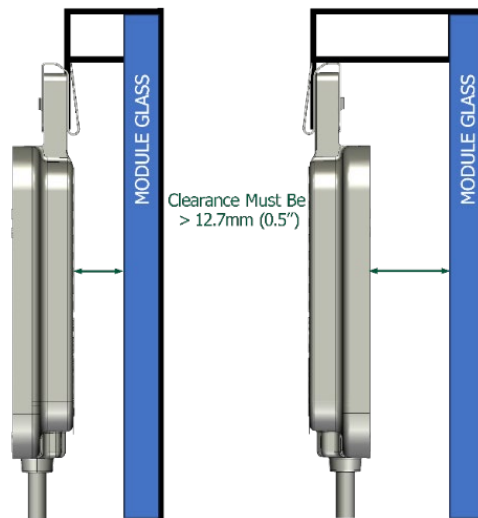

If using frameless modules, remove the clips and bolt the TS4 directly to the PV rail with M8 bolts and torque to 10.2Nm. No additional grounding is required.

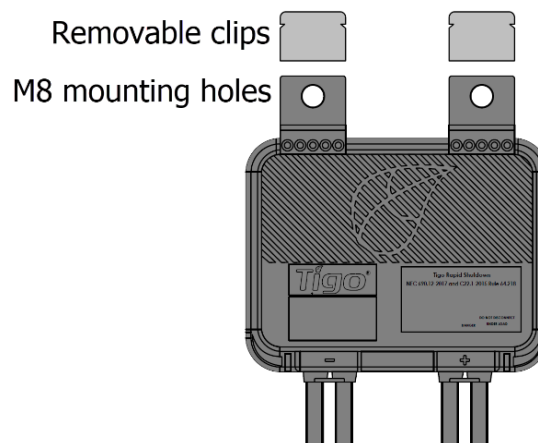

To install a TS4-O/S

1. Remove the QR/barcode sticker from the front cover and place it on a piece of cardboard or site layout template (EI Inverter only). The stickers should represent the actual location of the TS4 in the array.

An accurate physical map of the system is crucial for future maintenance. It allows for the quick and easy identification of individual modules with issues and ensures precise layout placement on the EI App and EI Portal.

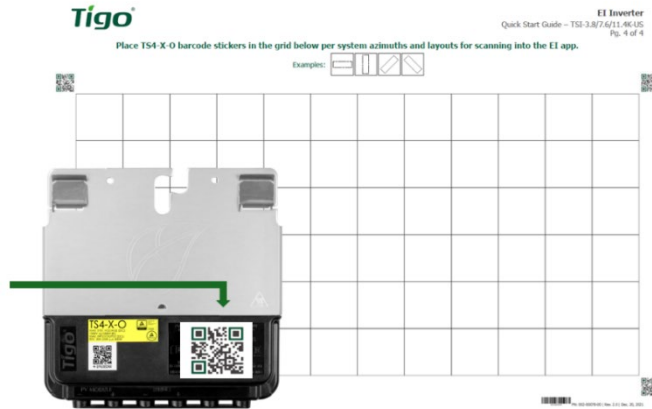

The TS4s must be installed in the following sequence. If not, irreparable damage may occur that is not covered by warranty.



You must connect the shorter TS4 input leads to the PV modules before connecting to neighboring TS4s. Failure to do so can damage the TS4 units.

2. Attach the TS4 to the top of the PV module frame using the silver clips with the cable glands facing down, or to the right or left at a 90-degree angle. Never install the TS4 with the glad seals facing upward.

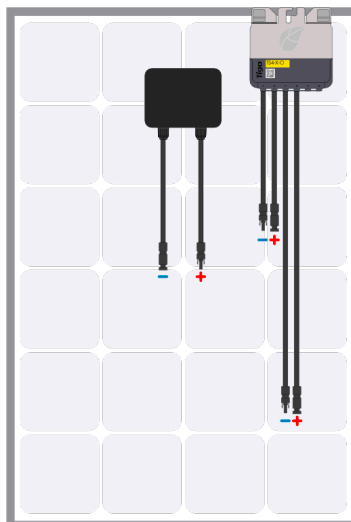

3. Connect the shorter TS4 input leads to the PV modules. *Always assume that TS4 units are in an ON state.*

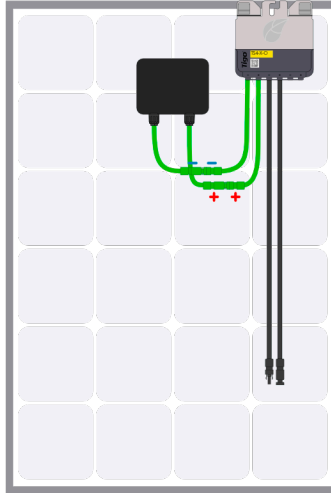

4. Connect the longer set of TS4 output cables to the neighboring TS4 to create a string.

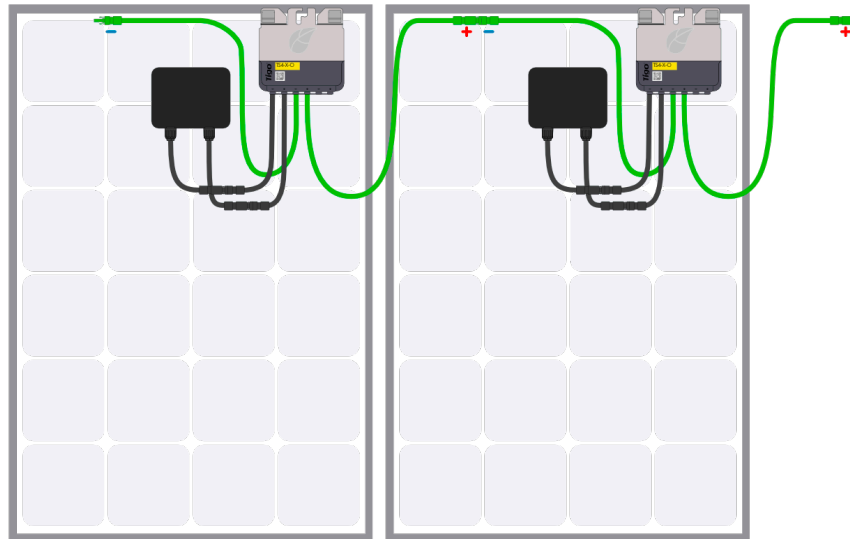

To disconnect a TS4:

- Activate rapid shutdown by turning off the CCA and inverter or by using the designated PV rapid shutdown system (PVRSS) initiator.
- Wait 30 seconds after a rapid shutdown activation before disconnecting DC cables.
- Disconnect individual TS4-O output cables from each other before disconnecting the TS4-O input cables from the module junction box.



Always assume that TS4 units are in an ON state and capable of passing full module voltage unless otherwise verified.

Install the CCA

A CCA and TAP enable monitoring and rapid shutdown for the TS4 -O and -S.

Install Procedure

To install a CCA:

1. Mount the CCA within a NEMA-rated enclosure that is suitable for the site environment: indoors, minimum NEMA 1; outdoors, minimum NEMA 4.
2. Connect the TAP RS-485 wires to the CCA *GATEWAY* port:

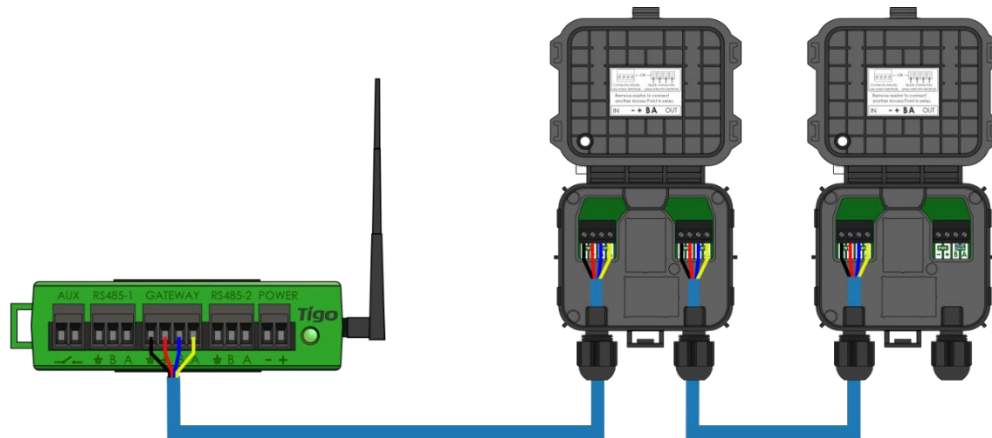

3. If used, connect any 3rd-party devices using Modbus to the *RS-485 1* and *RS-485 2* terminals:

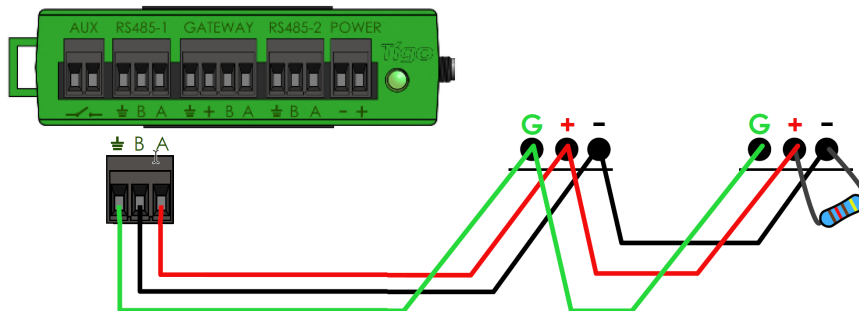

- All devices must have a unique Modbus address.
- Devices connected in series must have the same baud rate, parity, and stop bit settings.
- A 120Ω resistor must connect the + and – terminals on the last Modbus device.

For a list of supported Modbus devices, refer to the [Supported RS-485 Devices](#) Help Center article. For details about using Modbus, refer to [How-To: Setup and Monitor Modbus Connected Devices \(Inverters, Meters & Sensors\)](#).

- Connect the power supply's DC output leads to the CCA power terminals:

Rail power supply:

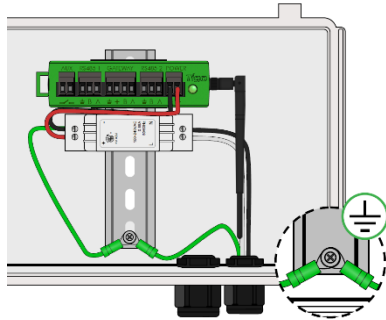

External power supply:

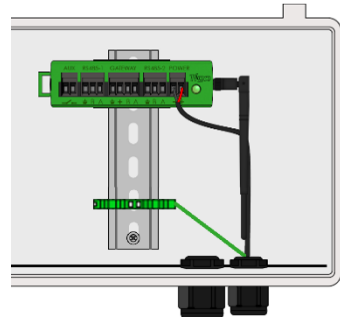

Complete all communications connections before powering on the CCA.

LED Status Indicators

The LED on the right of the CCA indicates system status as well as the status of the commissioning *Discovery* process:

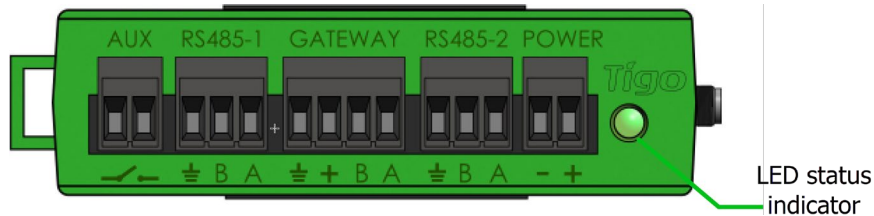

LED	State	Description
Solid green	System OK	The system is operating normally.
Blinking green/gray	SMART app activity	The CCA is connected to the Tigo SMART app.
Blinking green/yellow	User PV-Off	The PV-Off mode was manually activated.
Blinking yellow/gray	Discovery	The CCA is scanning for TAPs/TS4s.
Solid yellow	Warning	Scanning is incomplete or the CCA cannot connect to the Tigo server.
Blinking red/yellow	Auto PV-Off	The PV-Off mode was automatically activated.
Solid red	Error	CCA cannot find all TS4s or cannot connect to the Tigo server.

Use the Tigo Energy Intelligence (EI) app (available in the App Store or Google Play) to troubleshoot CCA issues

Install the Tigo Access Point (TAP)

A TAP communicates wirelessly with TS4 devices to gather monitoring data and enable rapid shutdown. The TAP communicates with a CCA via a ferruled 4-wire communication cable such as shielded RS-485. Refer to this Help Center article [TAP and GATEWAY Communication Cable Installation](#) for details.



Complete all TAP connections before powering on the CCA.

Install Procedure

To install a TAP using a ferruled four-wire RS-485 cable:

1. Run the cable from the CCA *GATEWAY* terminal to the TAP. If using more than 1 TAP per CCA, run the cable to the first TAP in the series.
2. Connect cable wires to the left side of the TAP terminal block.

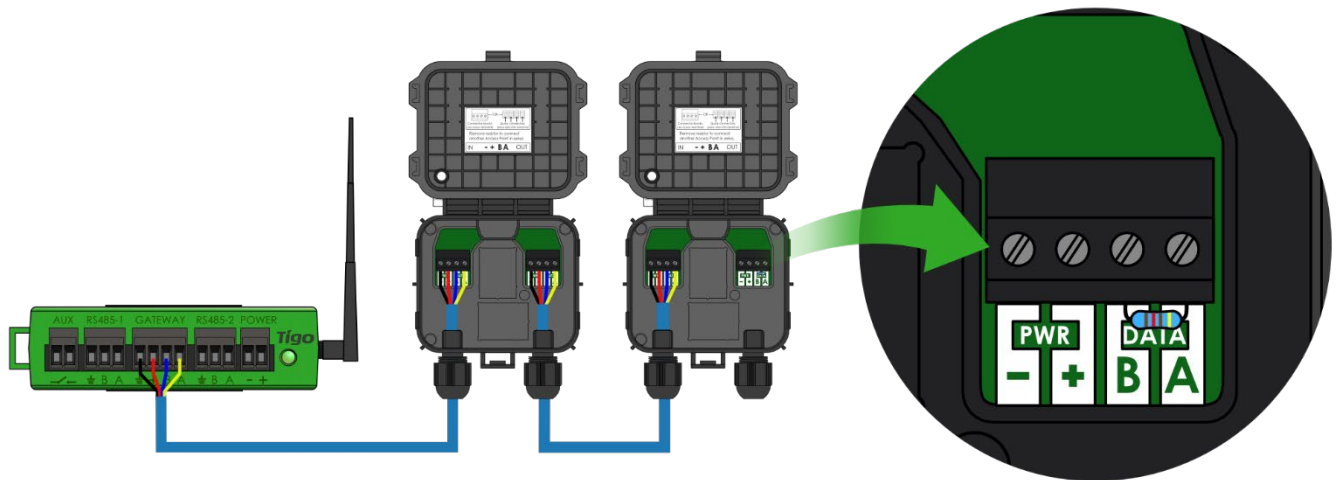

3. If connecting to another TAP, use the right-side terminals after removing the pre-installed 120Ω terminating resistor.
4. At the last TAP, leave the terminating resistor in the right-side terminal block.
5. Attach the TAP to the PV module frame. If using frameless modules, remove the clips with a screwdriver and mount directly to the module rail. Secure with two M8 bolts and torque to 10.2NM

Commissioning

Perform system configuration and registration with a browser at <https://ei.tigoenergy.com> or with the Tigo Energy Intelligence (EI) mobile app available in the App Store or Google Play. Final commissioning requires using the Tigo EI mobile app.

Browser

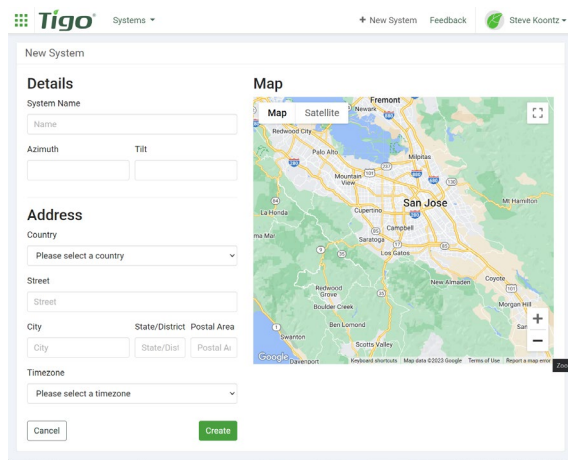

Mobile App

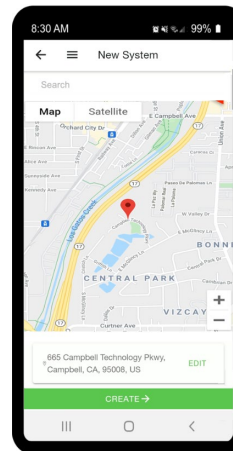

- Commercial installers can use a browser to enter the site layout of large numbers of TS4s and TAPs and then use the Tigo EI app to commission the system.
- Residential installers can use the Tigo EI app for the entire process.

Tigo Energy Intelligence App

The Tigo EI app for Android and iOS mobile devices enables easy system commissioning and provides comprehensive visibility into system and module performance.

Scan this QR code to download the app.



To run the Tigo EI app and commission the system, carefully complete all the following steps. If you want help, contact Tigo support within the app or via support@tigoenergy.com.

Create a New System

Before creating a new System, install and open the **Tigo Energy Intelligence** App on your cell or tablet. For full installation instructions, see [Install Tigo Energy Intelligence \(EI\) App](#).

1. Start a new system build by pressing the **+** symbol (top right)

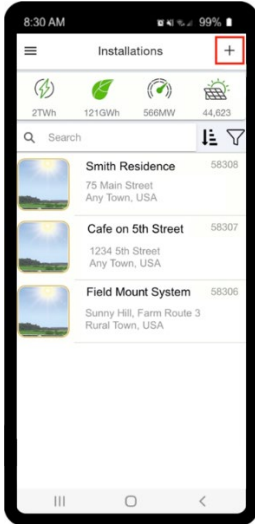

2. Checking Bluetooth and Location Permissions



3. Location Access Granted - Press **NEXT** button (bottom)

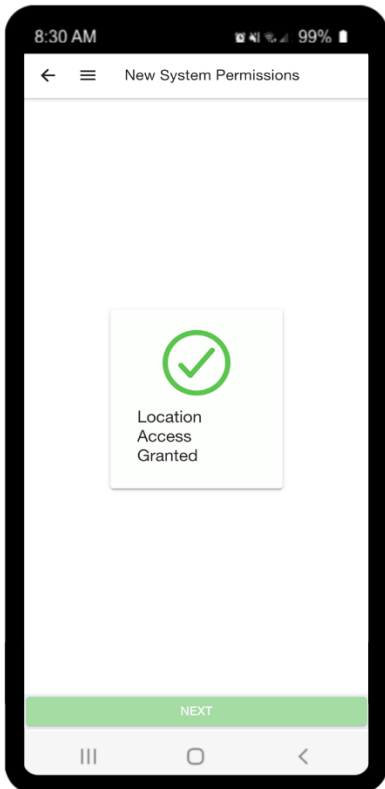

Note: To service or monitor an existing system, simply press any system (in the list).

Enter Site Info

In this section, you will enter all the pertinent information about the system, like name, address, and planned turn-on date (for system deployment to customers).

1. Press **System Name**, to type in new name
Press **Planned Turn on Date** to select date
Press **Advanced Options** arrow to set any other parameters
Select **NEXT**

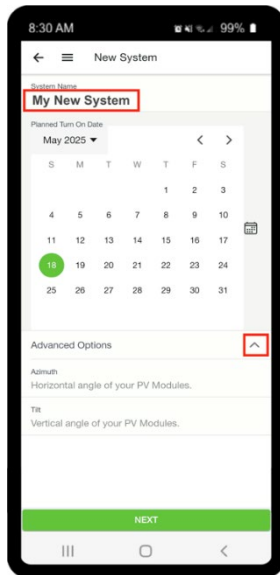

2. Press **CONFIRM** to confirm System Address or press **CANCEL** to enter a new address.

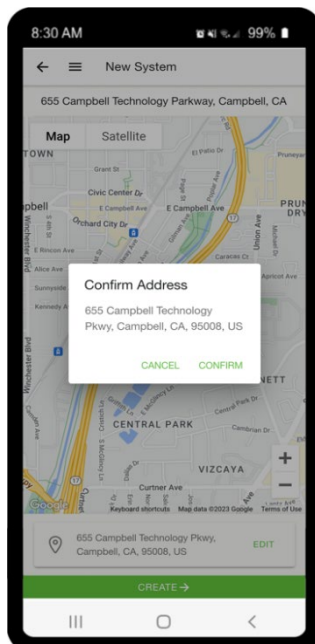

3. Press the **CREATE** -> button (bottom) to confirm

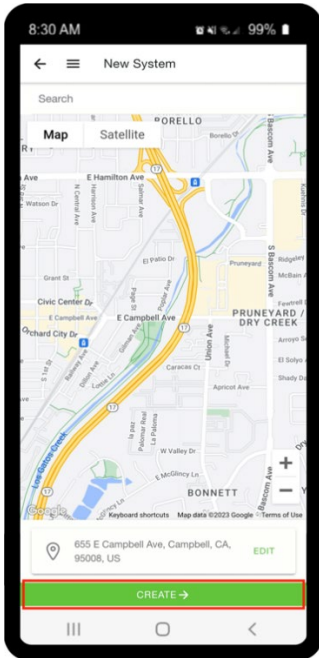

4. If **System Info** is valid, a green checkmark ✓ will appear
Press **System Info** to confirm accuracy or make corrections

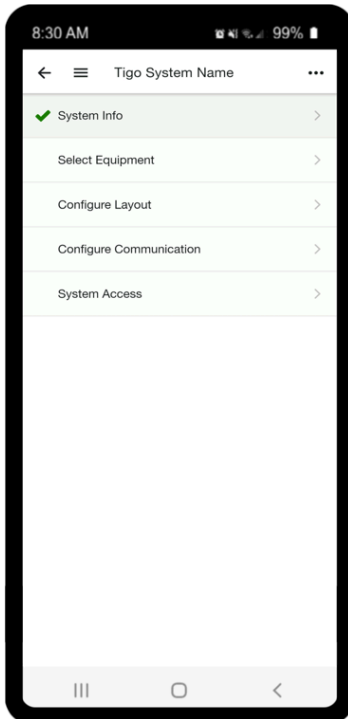

5. Press **EDIT** Button(s) to make corrections within the sections.
When complete, press the **Back Arrow** button to return (upper left corner).

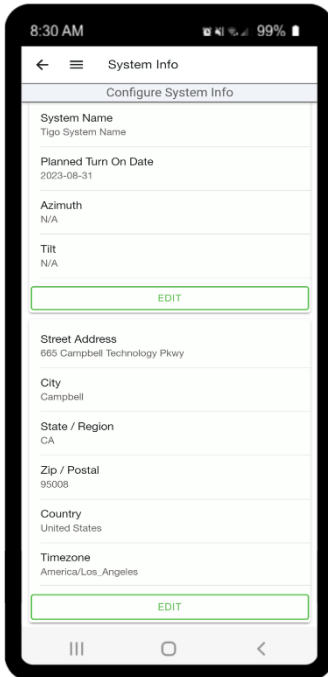

Select Equipment

In this section, you will be adding and assigning the new CCA, Strings, PV Modules, and Inverters to the System.

Add Cloud Connect Advanced (CCA):

1. Press **Select Equipment**

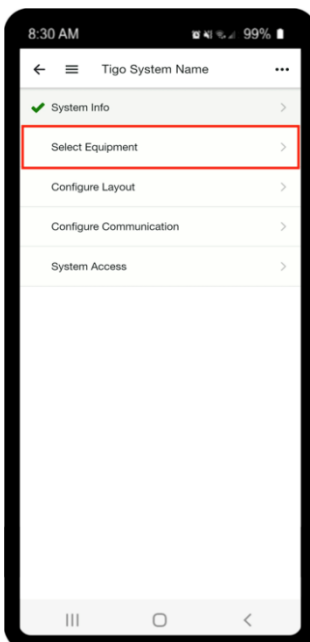

2. Press the green  bubble to add equipment

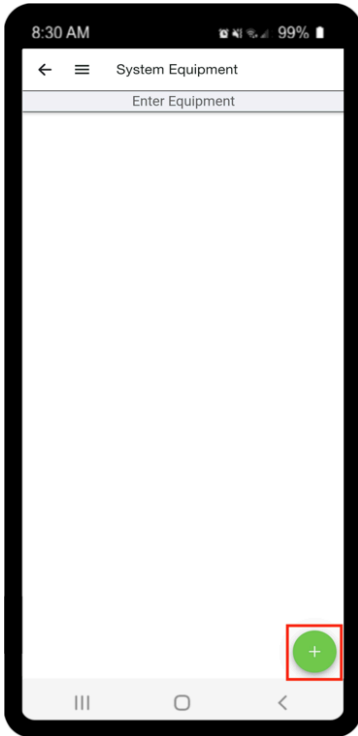

3. Select **Add** to enter the new CCA information

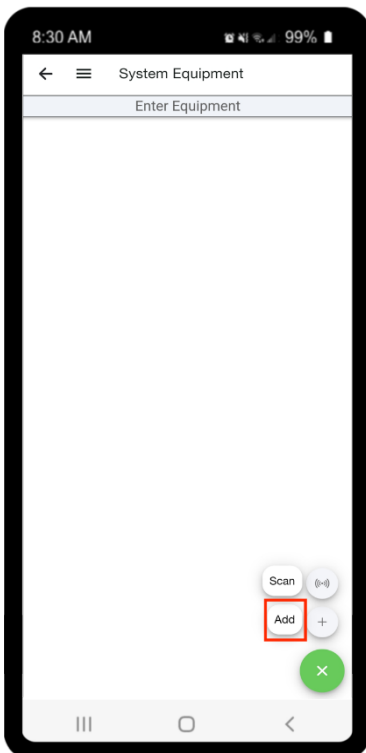

- 4. Select **Cloud Connect Advanced - (CCA)** at bottom menu

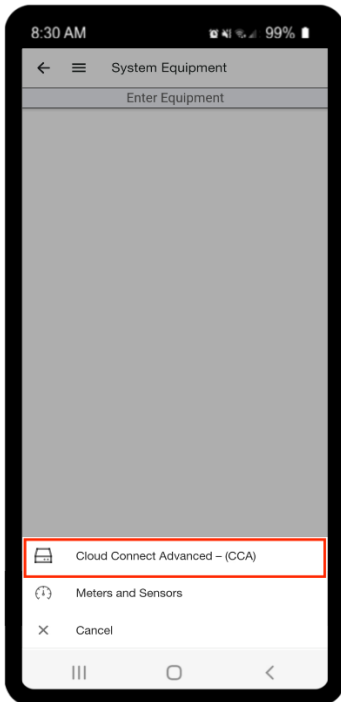

- 5. Enter **Name**

Enter **Serial**, (or press **SCAN** button to open camera and scan CCA bar code)

Enter **Number of TAPs** for system

Press **ADD** button (bottom)

Note: When using the **SCAN** function, select **Allow** to let the Tigo app access the device's camera. Position the device camera, so that the sticker fills the center screen (on red scan line).

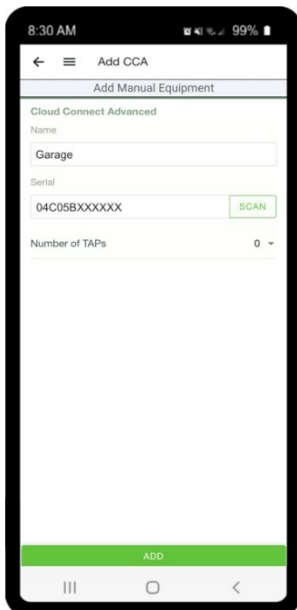

6. Press **SAVE** to return to **System Equipment**

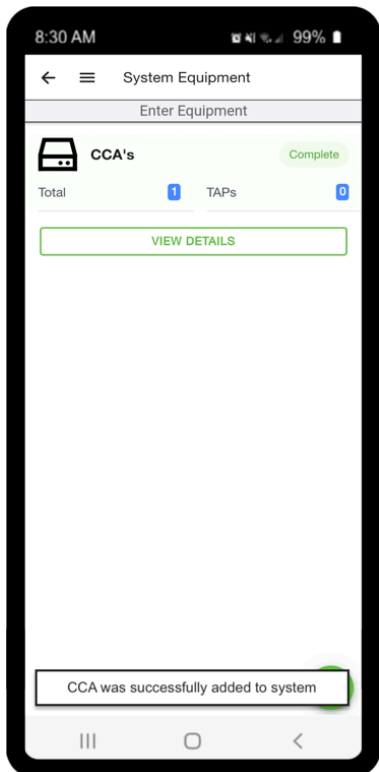

Important Notes:

- **For multiple CCA systems:** Enter a unique name for each CCA, like a physical location (Garage) or what it manages (strings, inverter, etc.). This can help future installers or site owners locate the correct CCA in the system.
- **Number of TAPs:** Accuracy is important! If the Number of TAPs is incorrect, the Discovery will not proceed. Entry of Serial Numbers for the TAPs is not needed, as the TAPs automatically communicate (via wiring) with the CCA.

Add Inverters & PV Modules

1. Select the green  **bubble** and choose **Add**

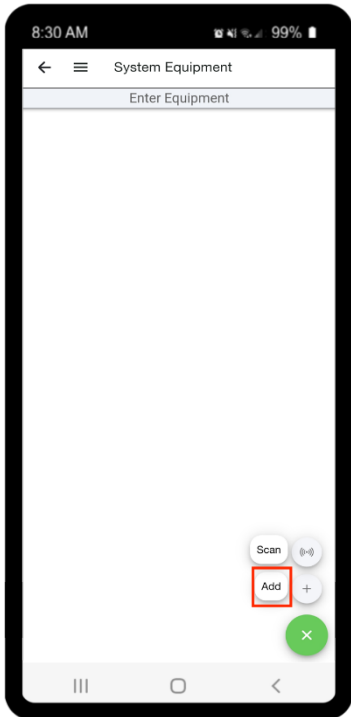

2. Choose **Inverter and PV Modules**

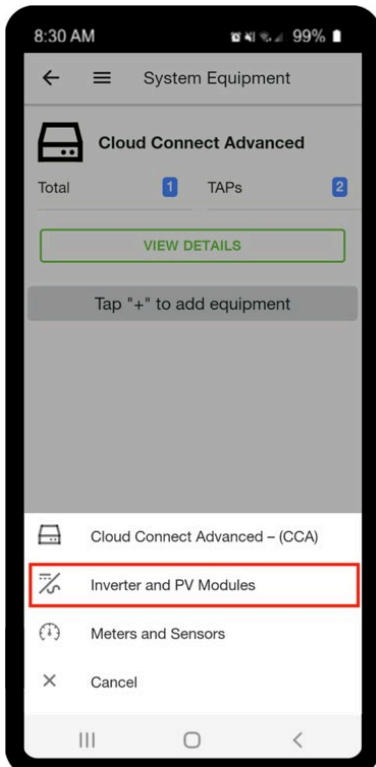

- 3. **Name** Inverter and add **Manufacturer** and **Model** of **Inverter** and **PV Modules**
Add the **Number of Strings** (associated per MPPT) and how many **Panels per String**
(*check **Uneven Strings** box if length or number of Panels per parallel strings is not equal)
Press **SAVE** button (bottom) to return to **System Equipment**

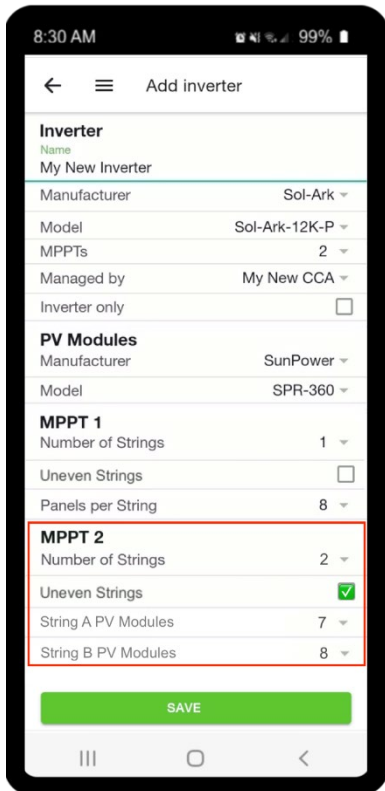

Important Notes:

- **For multiple Inverter systems:** Enter a unique name for each Inverter, like a physical location (i.e., southwest roof) or what it manages (strings, inverter, etc.). This can help future installers or site owners identify the correct Inverter in the system.
- **When selecting Inverter or PV Module:** If the Make or Model is not available on the list(s), press the + sign at the top right corner to add a new item.
- Add meters and sensors **only** if you have realized a direct Modbus connection between our CCA and your meters/sensors/inverters.

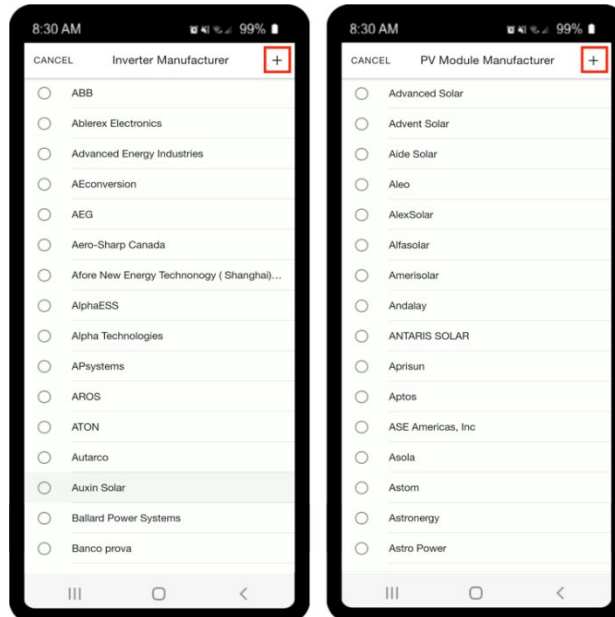

- **Enter the Name and press SAVE when complete.**



Note: Newly added equipment listings will be private to this system (only), until they have been verified by Tigo Staff.

Configure Layout

After you have completed **System Equipment**, select the **Back Arrow** ← (upper left corner) to return to **My System**. The **Select Equipment** option will now show a green checkmark ✓.

1. Select **Configure Layout**

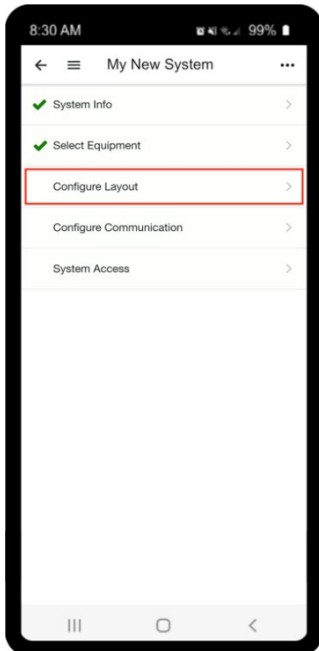

2. Layout shows an empty grid with a **Toolbox** (top) and an **Equipment Selector** (bottom)

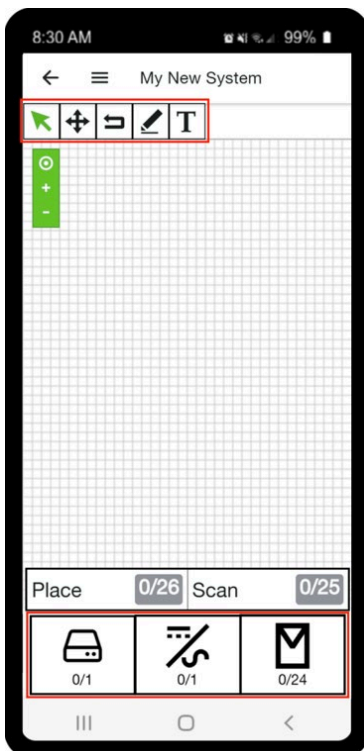

The symbols in the **Equipment Selector** represent the items that you will be placing on the grid. Select the correct symbol and press on the grid, to place the item.

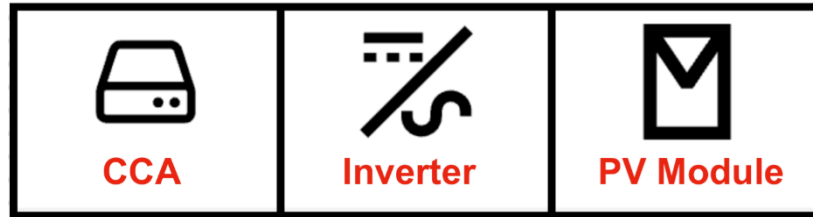

Once all the equipment has been placed on the grid, select the **Arrow Symbol**  (top left of toolbox) and press-and-drag an item, to move it:

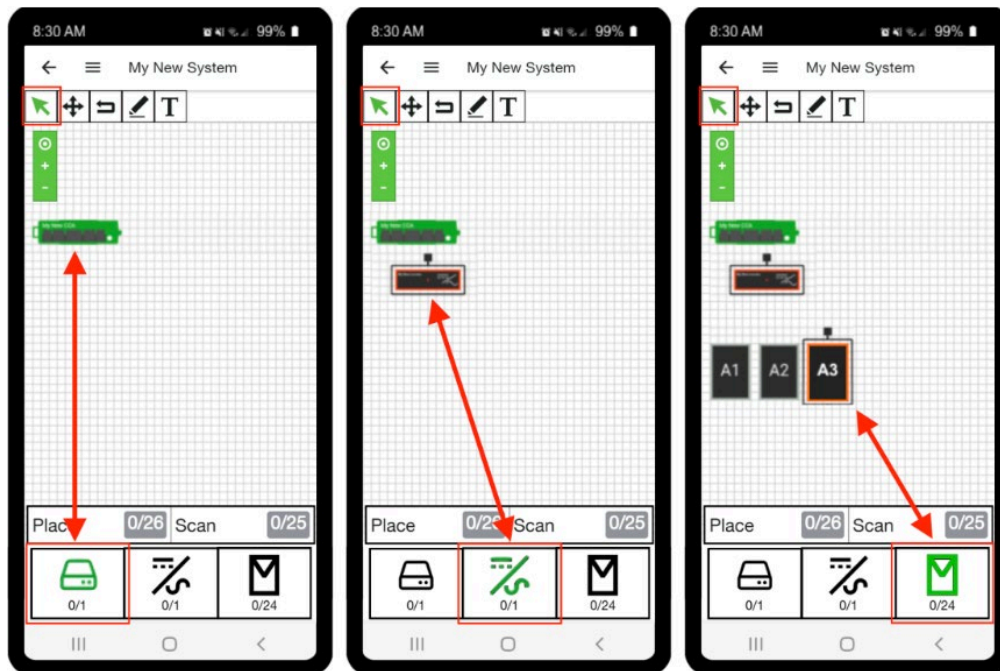

When placing PV modules: the Tigo EI App places items in a linear fashion. After you place Module **A1**, the **A2** Module will automatically be next (when pressing on the grid). Do this until all the A string modules are placed, and then the B String modules will automatically be the next available item(s). Repeat until all modules from all strings are placed on grid.



It is essential to place the modules on the Layout screen as they appear in the physical layout.

An accurate site map enables understanding of shading effects on production and energy recovery. This also assists future maintenance activities requiring accurate physical location of Tigo MLPE's.

After all the PV modules have been placed, the next steps involve entering (or scanning) the serial numbers for all the Tigo MLPE units on the system.

1. Choose the **Scan** selection button (lower right)

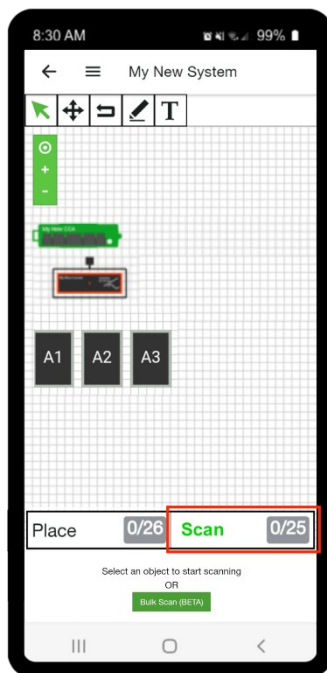

2. Press on a PV Module. The app will automatically zoom in to that location and offer the **Module Entry Field** at the bottom of the page.

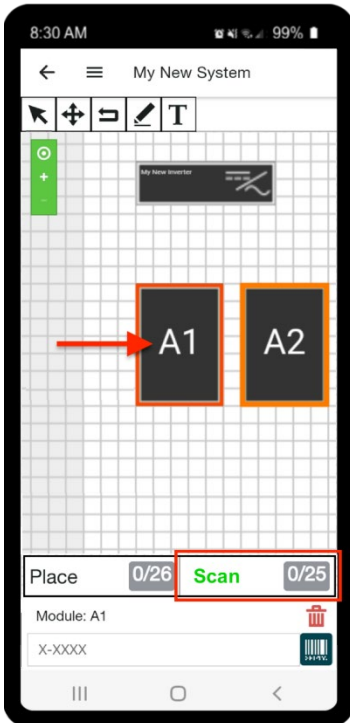

3. Select **Module Entry Field** (bottom) to type the serial number or press the **Serial**  button to open the camera and scan the MLPE's label.

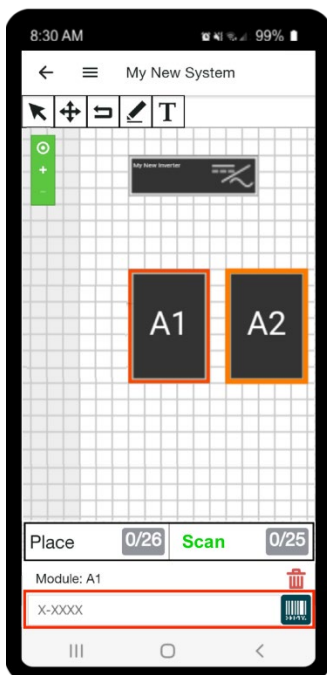

 **Pro Tip:** The **QR Code** feature is the quickest way to add units, while on the job site. Simply scan the **QR Code** button to open the camera, and you can auto-scan each label as they come out of the box, or as you have them racked in sequence.

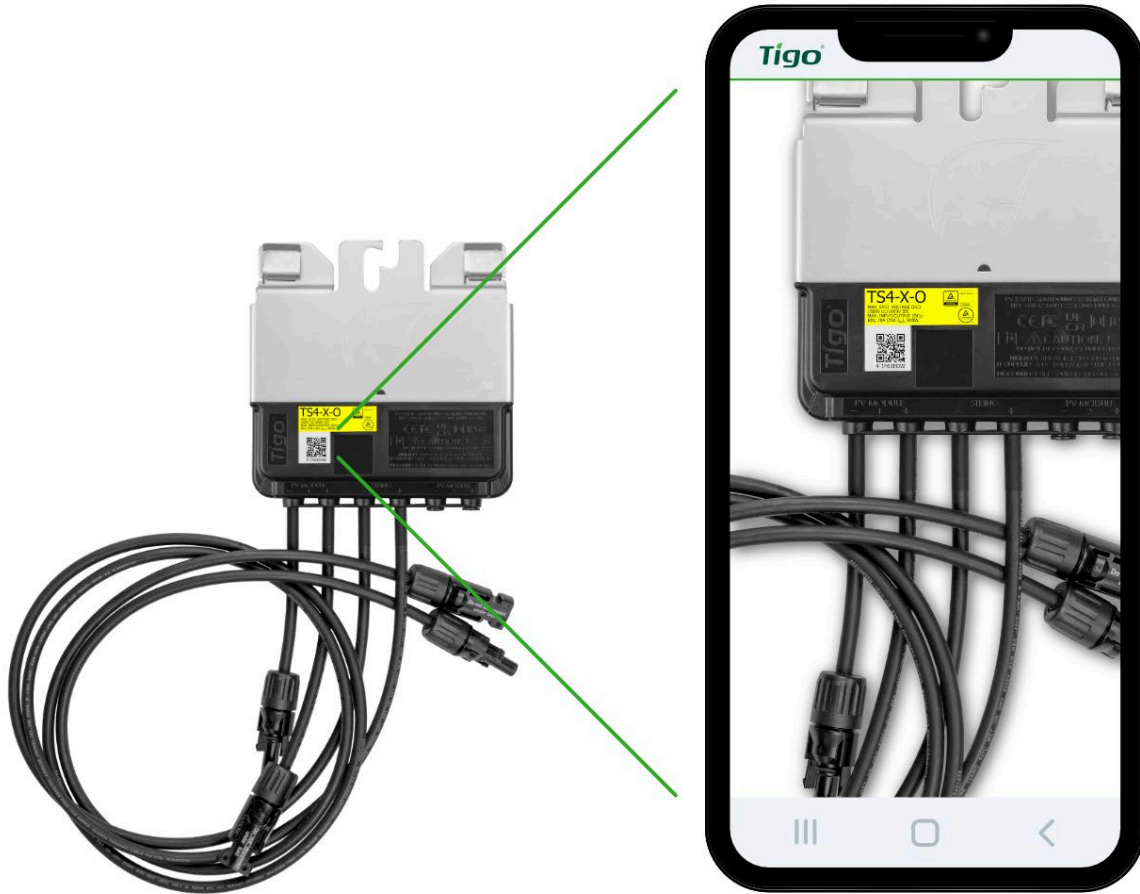

After a QR code is entered (or scanned), the App will automatically proceed to the next PV Module in the string. You may change or delete the QR code by pressing on the desired PV Module and entering a new serial or selecting the red trash icon .

After you have entered all the MLPE serial numbers, press the **Back Arrow** ← symbol (upper left corner) to return to **My System**. When complete, **Configure Layout** will show a Checkmark ✓.

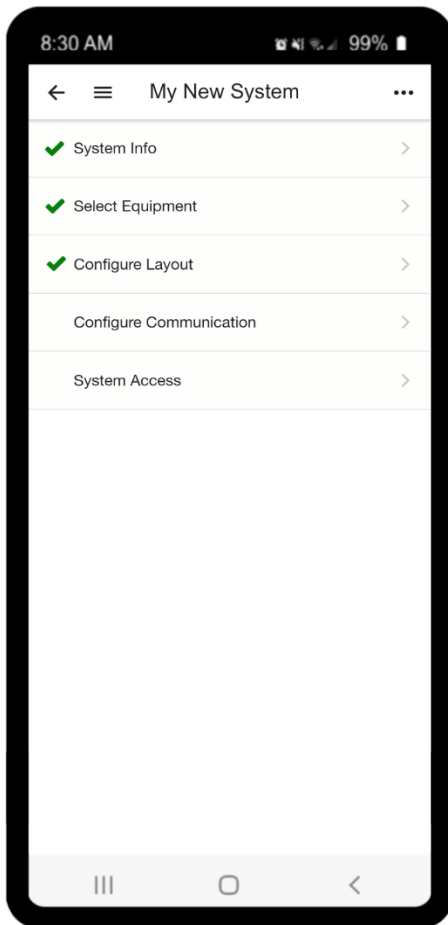

This completes the **Create and Edit System** step of the commissioning process.

TS4-F Design

RSS Transmitter Design Considerations

Tigo's Fire Safety products work with an RSS Transmitter to enable a code compliant Rapid shutdown system. When this transmitter is powered on, the RSS core will transduce a Power Line Communication (PLC) signal onto the string wiring. This is sometimes referred to as a "keep-alive signal," as the MLPE units will only respond if the signal is active.

When the PLC transmitter is powered off, this keep-alive signal is no longer present, and the entire DC-side of the system goes into a RSD response: *The Tigo TS4-F MLPEs disconnect their PV-Modules from the string, and the accumulated string voltage is reduced to under 80V within 30 seconds (as per NEC requirements).*

The RSS transmitter with Pure Signal technology mitigates crosstalk risk by syncing the keep alive PLC outputs of multiple transmitters.

- The RSS transmitter requires a 12-volt, 1 amp DC power supply. Multiple transmitters must use the same breaker to ensure all transmitters power cycle at the same time.
- RSS transmitter power supply is available in a 120-volt or a commercial 277-volt version. If you are using a third-party power supply, it must be rated to 12 volts and 1A. Power supplies with lower current ratings can cause system abnormal behavior.
- Each Core accommodates up to 10 DC conductors from the array. A PV inverter MPPT input with more than 10 strings must use two Cores, up to 20 conductors in total.



- When using a single-core transmitter, the entire length of the DC run should be less than 300 meters to maintain signal strength and integrity. Distances over 300 meters using a single Core may cause abnormal TS4 behavior.

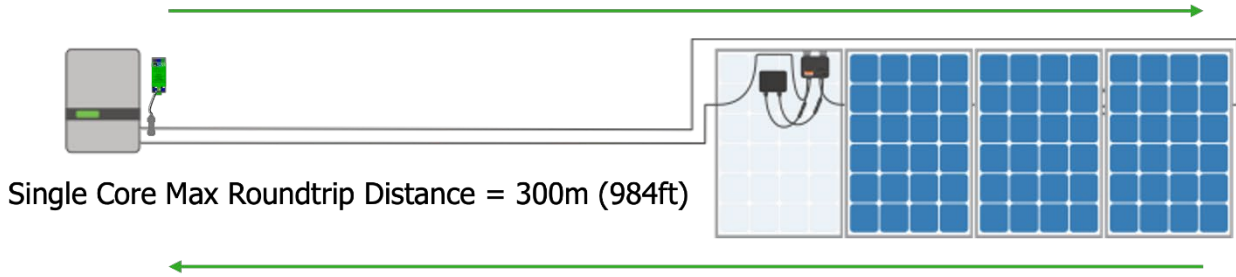

- If the DC run exceeds 300 meters, use a two-Core RSS transmitter to boost signal strength.
- The two-core transmitter provides a strong, keep-alive signal of up to 500 meters.

Do not separate the positive and negative conductors of the same string. Keep them in the same conduit or cable tray. If they are separated, the keep-alive signal strength is weakened, resulting in abnormal TS4 behavior.

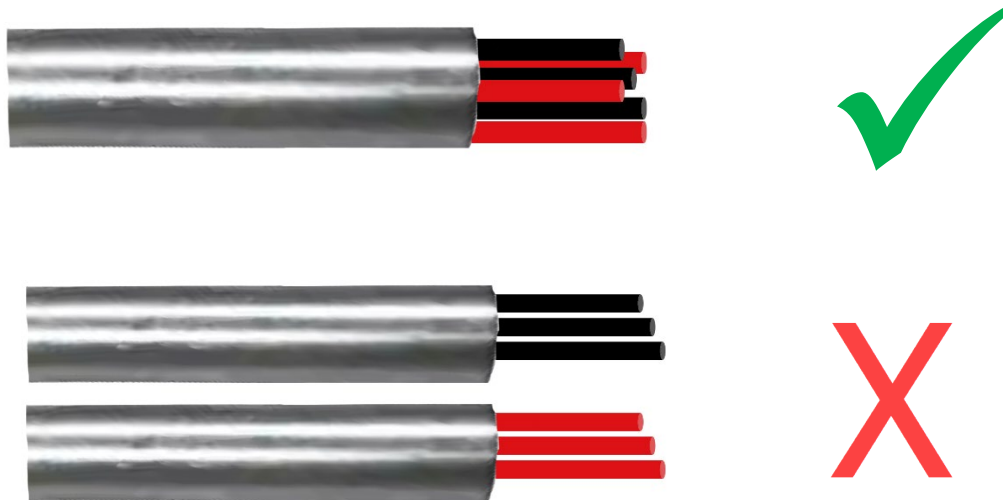

Large Commercial and Utility Site Considerations

Tigo Pure Signal technology (PST) enables one group of up to ten RSS transmitters to synchronize their power-line communications (PLC) to up to 200 PV strings, ensuring reliable rapid shutdown using Tigo TS4s.

However, when deploying multiple groups of transmitters (>10), specific requirements must be met to preserve proper, safe performance. These requirements are that you:

- Obtain Tigo Design Review
- Layout PV Conductors to Minimize Crosstalk
- Turn All Groups On/Off Simultaneously

Install RSS Transmitters

One transmitter can support up to ten strings with one core and up to twenty strings with two cores. To take advantage of Tigo Pure Signal technology (PST), up to ten transmitters may be connected to form a group.



CAUTION!

If installing multiple groups, consult with Tigo sales engineers regarding proper system design to minimize crosstalk and other EMI. You must follow required practices for [PV Conductor Layout and RSS Signal Integrity](#).

An RSS transmitter:

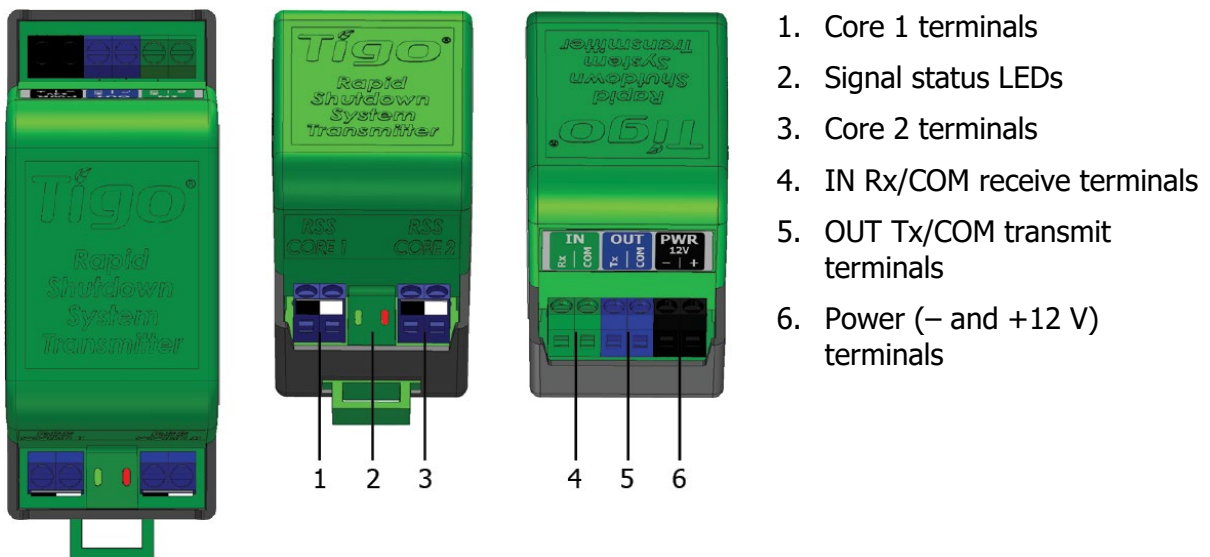

1. Core 1 terminals
2. Signal status LEDs
3. Core 2 terminals
4. IN Rx/COM receive terminals
5. OUT Tx/COM transmit terminals
6. Power (– and +12 V) terminals

To install one or more RSS transmitters, you will:

- Install an Enclosure
- Connect a Power Supply
- Connect a Core
- Connect Signal Wiring
- Check Transmitter Status LEDs
- Post an RSS Label

Install an Enclosure

RSS transmitters are NEMA 1 (indoor) rated. If installed outdoors or exposed to weather, they require a NEMA 4-rated enclosure with a 35 mm DIN rail.

Two optional Tigo outdoor kits include enclosure, RSS transmitter, power supply, and DIN rail components.

RSS Transmitter Outdoor Kit for One Transmitter

The Tigo RSS Transmitter Outdoor Kit for one transmitter for 120/240 V grid feeds includes:

- One IP67/NEMA 4X-rated enclosure
- One RSS transmitter
- One 100-240 V 12 V/1 A power supply

The transmitter and power supply are mounted on a 35 mm DIN rail. The enclosure dimensions (W x D x H) are 203 x 115 x 278.4 mm (8 x 4.5 x 11 in.).

RSS Transmitter Outdoor Kit for Two Transmitters

The Tigo kit for one or two transmitters for 277/480 V grid feeds includes:

- One IP67-rated enclosure
- One RSS transmitter
- One 180-550 V 12 V/10 A power supply

The transmitter and power supply are mounted on a 35 mm DIN rail. The enclosure dimensions (W x D x H) are 300 x 180 x 400 mm (11.8 x 7.1 x 15.75 in.).

To order a kit or additional transmitters and power supplies, contact your local Tigo distributor or [Tigo Sales](#).



CAUTION!

Follow code carefully when fitting conduit and conductors to ensure watertight performance, proper box-fill, and safe cable bends.

Moisture will damage both the power supply and RSS transmitter.

Connect Power Supplies

Residential applications must use a 12V/1A DC power supply for 120V power. For commercial applications, you must use a 12V/1A power supply with 480/277V input power. Since commercial applications typically use multiple transmitters, you may use a 12V/10A power supply to power up to 10 transmitters in the same group.

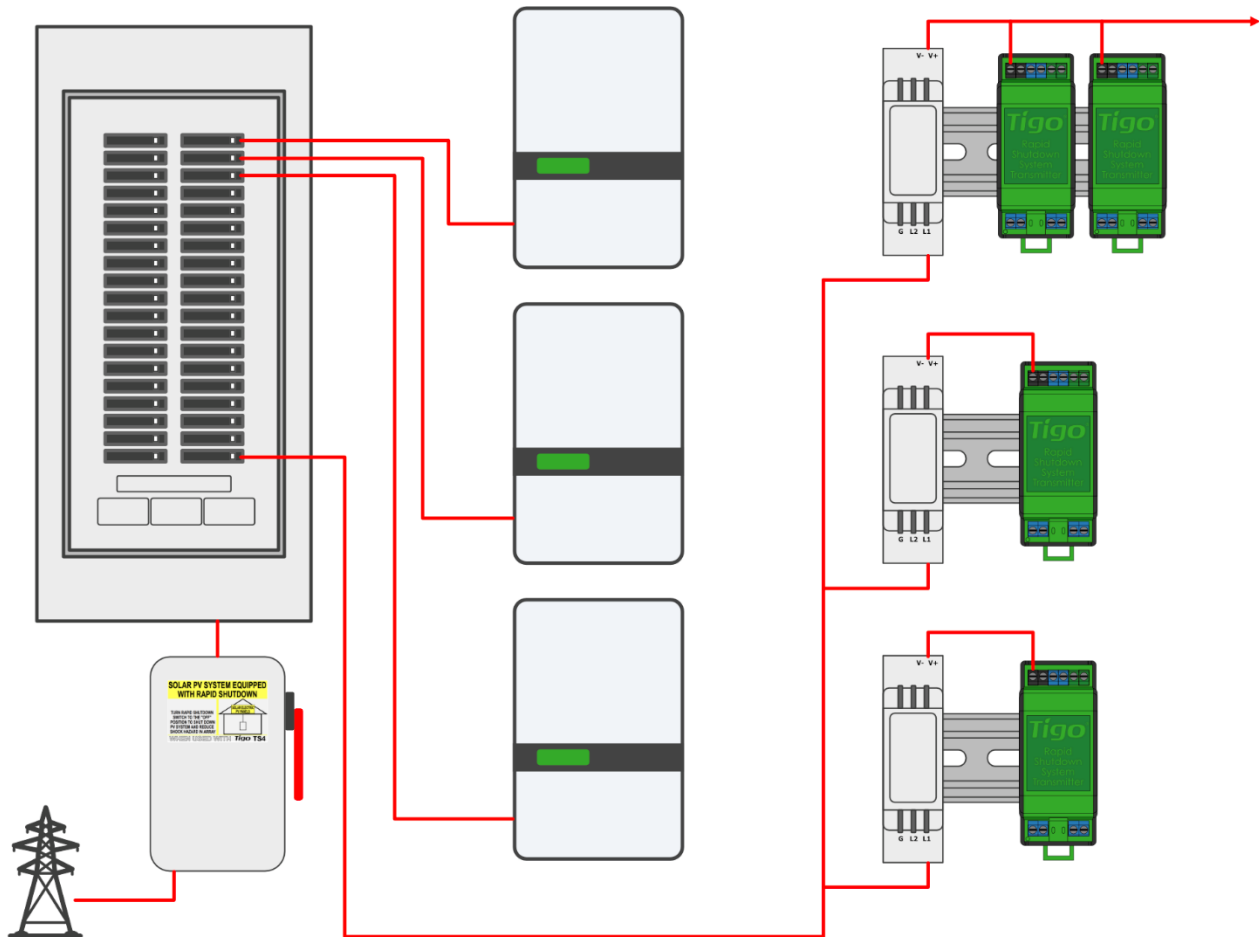

CAUTION!

non-Tigo power supplies must reliably output 12 V ($\pm 2\%$) 1 A current for a single transmitter and 12 V ($\pm 2\%$) 10 A current for multiple (up to ten) transmitters.

Tigo power supplies meet ride-through interconnection requirements such as California’s Electric Rule 21.

To connect a residential 120 VAC, 12 VDC/1A power supply to a transmitter:

1. Turn off all AC power sources.
2. Connect a ground wire to the power supply V- output terminal.
3. Connect AC conductors and torque to 0.4 Nm.
4. Use ferruled leads to connect 12 V output to the transmitter PWR terminals and torque to 0.4 Nm. Double-lug the ground and 12 V negative conductor at the power supply.

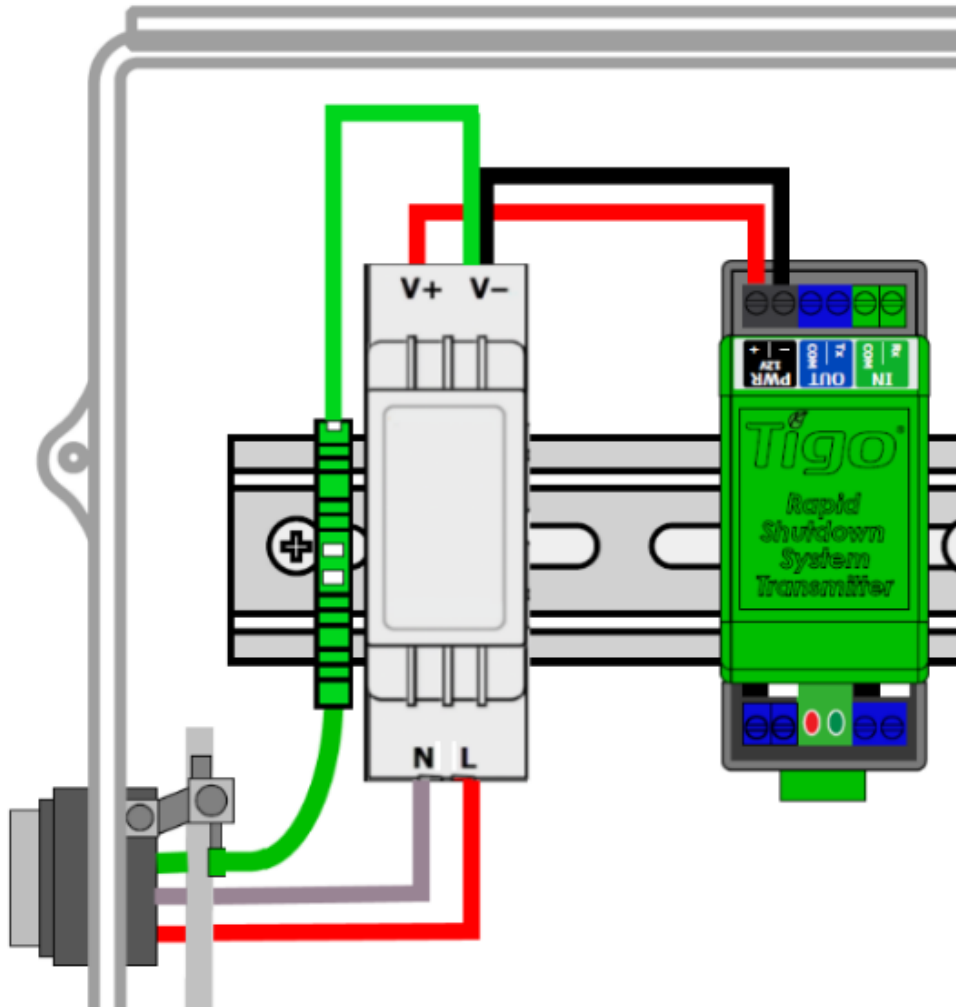

To connect a commercial 480/ 277 VAC, 12VDC/1A power supply to a transmitter:

1. Turn off all AC power sources.
2. Connect ground, L2, and L1 AC conductors and torque to 0.4 Nm.
3. Use ferruled leads to connect 12 V output to the transmitter PWR terminals and torque to 0.4 Nm.

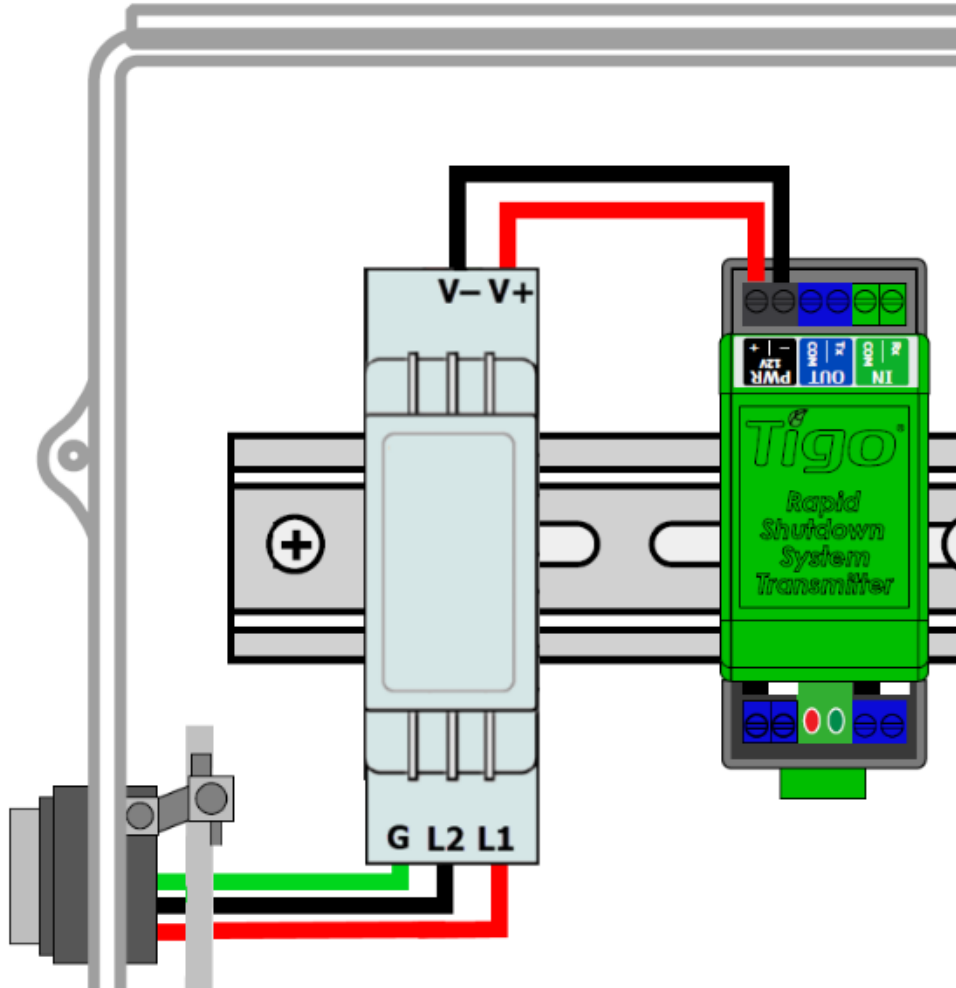

- If connecting multiple (up to ten) transmitters within the same group¹, use parallel connections with DIN rail terminals between all PWR terminals.

Use wire AWG appropriate to the distance between transmitters.

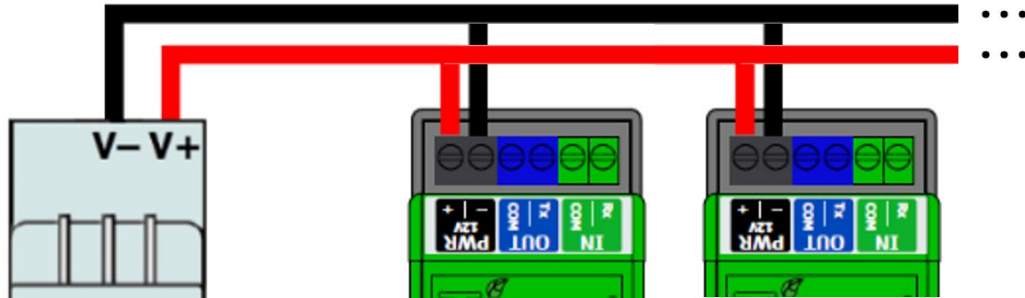

Connect a Core

You may connect one or two cores to a single transmitter.

To connect a core to the transmitter:

- Insert the core wire with a white ferrule into the transmitter white *Core 1* terminal and torque to 0.4 Nm.

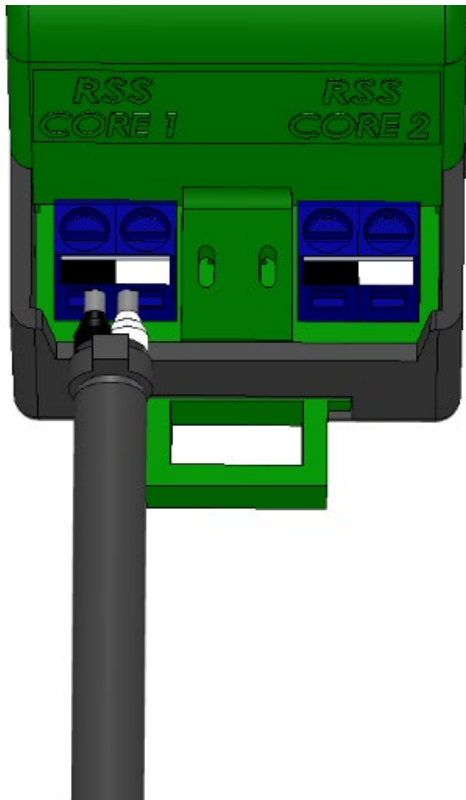

¹ Currently not UL-certified for use with multiple transmitters.

2. Insert the core wire with the black ferrule into the black terminal. Torque to 0.4 Nm.
3. Repeat the procedure at the *Core 2* output for two-core applications.



CAUTION!
Do not modify or extend the wires between a transmitter and its core.

To route PV conductors:

1. Route PV conductors into the enclosure.



CAUTION!
If necessary, positive PV conductors may be routed outside the enclosure for a maximum of 1 m (3.3 ft.). These conductors must be at least 20 cm (8 in.) distant from conductors using a different transmitter.

2. Pass up to ten negative string conductors through a transmitter core.

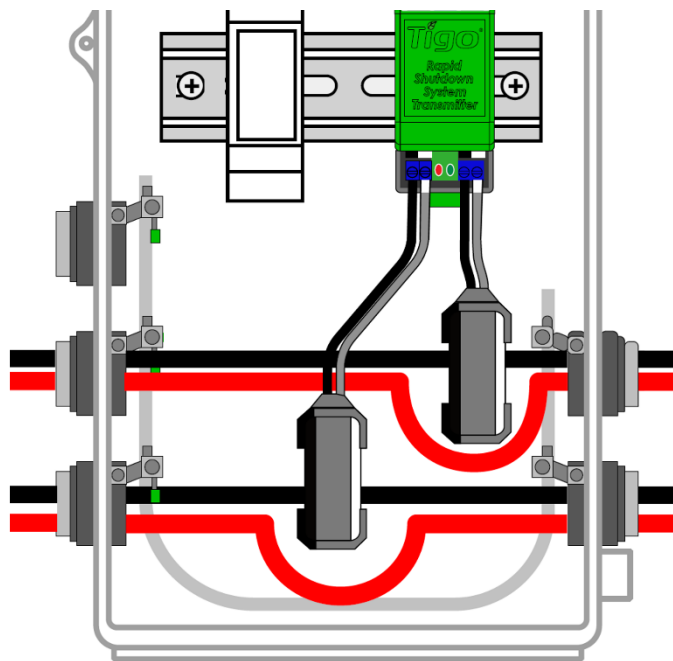

To PV array

To inverter

The black side of the core must face the PV array.

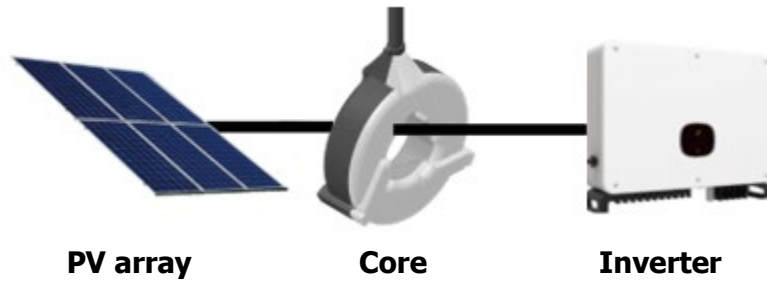

Amplify a Signal with Two Cores

Two cores may be used in series to amplify the RSS signal from a single transmitter. This may be appropriate with home run strings between 300 m (1000 ft.) and 500 m (1650 ft.) and in other special cases. Contact [Tigo Sales Engineering](#) for more information.

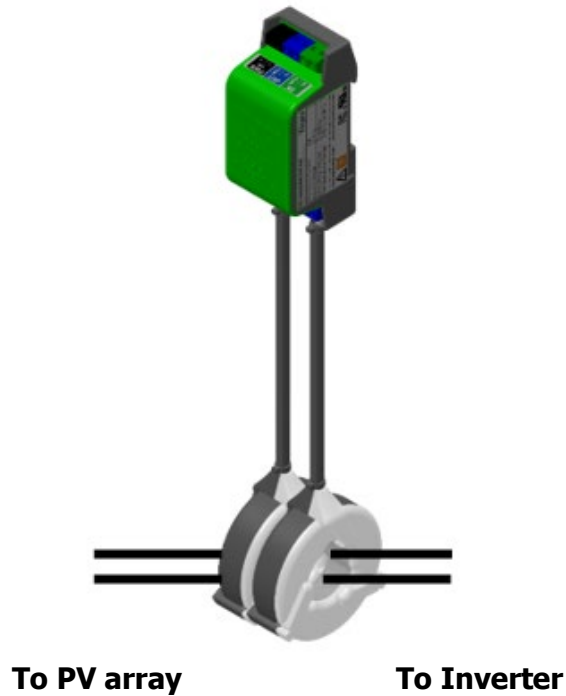

Connect Signal Wiring

To connect signal wiring between multiple transmitters in a group, use 14 – 22 AWG wire. Torque all terminals to 0.4 Nm.

The maximum length of signal wire between the first and last transmitters is 30.5 m (100 ft.).

The first transmitter in a group is the “leader.” Subsequent transmitters are “followers.”

To connect signal wiring between multiple transmitters:

1. Turn off all AC power sources.
2. Connect the leader *OUT Tx* terminal to the follower *IN Rx* terminal.
The leader *IN* terminals should always be unconnected.
3. Connect the leader *OUT COM* terminal to the follower #1 *IN COM* terminal.
4. Connect the follower *OUT Tx* terminal to the next follower *IN Rx* terminal.
5. Connect the follower *OUT COM* terminal to the next follower *IN COM* terminal.
6. Repeat the connections as needed.

The last follower *OUT* terminals should always be unconnected.

The total length of signal wire from the first to the last transmitter should not exceed 100 feet.

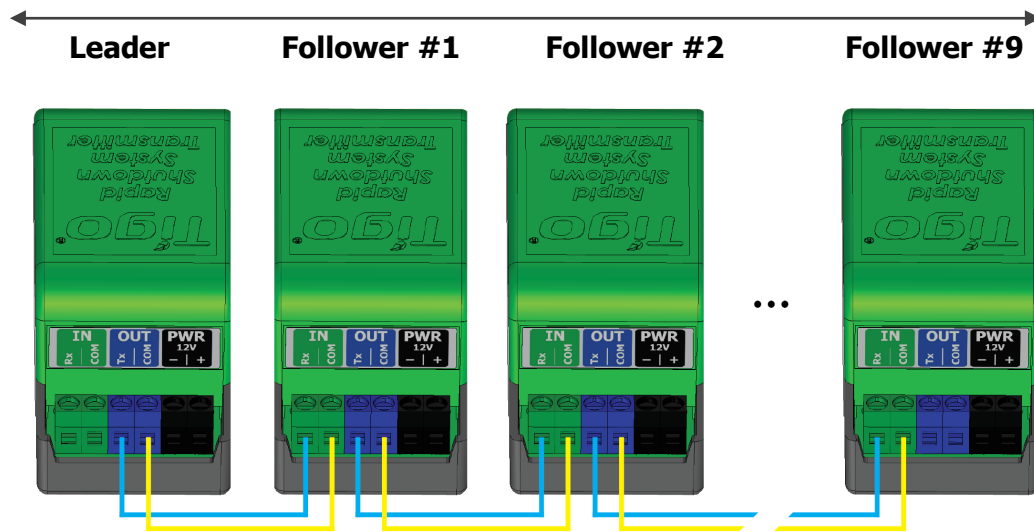

CAUTION!

Check that signal (*Tx/Rx*) wires never connect to *COM* terminals.

Check Status LEDs

If connected correctly:

- The leader transmitter displays a continuous red LED and a blinking green LED.
- Follower transmitter LEDs blink green simultaneously with no red.

Refer to the [Testing and Troubleshooting](#) section of this manual if LEDs are blinking otherwise.

Post an RSS Label

After installing TS4s and transmitters, place an RSS label within 1 m (3 ft.) of the RSS initiator (Refer to NEC 690.12(C)).

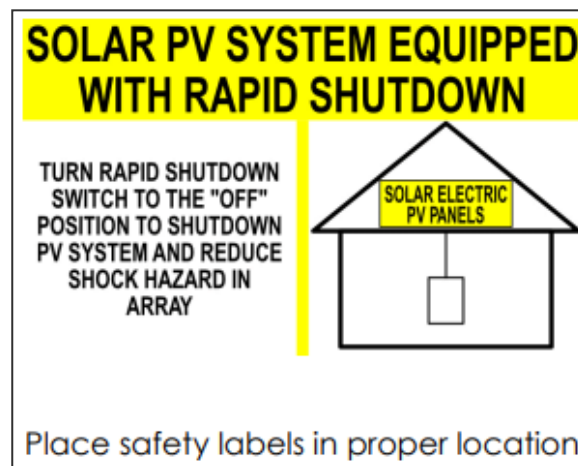

Commissioning and Operations

This section includes the following topics:

- Commissioning Checklist
- Energize RSS Transmitters
- De-Energize RSS Transmitters
- Partial Site Shutdown

Commissioning Checklist

Before energizing a transmitter group, first ensure all the following conditions are met:

- All solar modules are connected to a TS4-F.
- The black sides of all RSS cores face the PV array.
- Only negative conductors run through an RSS core.
- PV conductor's home run length is ≤ 300 m (985 ft.) with one core or between 300 m (985 ft.) and 500 m (1650 ft.) using two cores.

- Signal wires between multiple transmitters are between *OUT* and *IN* terminals on each transmitter and connections are secure.
- Power supplies are wired correctly.
- All conduit attachments are secure.
- Measured string safety voltage should be $0.6V \times$ the number of TS4-F in the string $\pm 1\%$ the total expected string safety voltage. If any string has greater or less than expected safety voltage, de-energize the system and correct the issue before continuing.
- The PVRSS label is within 914 mm (3 ft.) of the Tigo E-Stop switch or other rapid shutdown initiation device.
- There is a common system wide initiator/switch that turns off all inverters and all transmitters simultaneously.
- Any built-in inverter PLC transmitters not used by the Tigo RSS system must be disabled.

**CAUTION!**

All transmitters in a group should be energized and de-energized at the same time. One way to do this is to install a single AC breaker that powers all the transmitter group power supplies.

Energize RSS Transmitters

For each transmitter group:

1. Turn on AC power to all transmitters and/or inverters in the group.
2. Verify transmitter LEDs:
 - The leader transmitter displays a continuous red LED and a blinking green LED.
 - Follower transmitter LEDs blink green simultaneously with no red.
3. Insert all DC string fuses (if equipped).
4. Turn on all AC switches for inverters in the group.
5. Turn all DC switches on inverters in the group.

De-Energize RSS Transmitters

For each transmitter group:

1. Turn off the AC breaker to transmitters and/or inverters in the group.
2. Turn off AC switches on each inverter in the group.
3. Wait at least 30 seconds for the inverters to discharge.
4. Turn off DC switches on inverters in the group.
5. Remove DC string fuses (if equipped).

Unpowered String Measurements – Safety Voltage

A TS4-F is connected to one or two solar modules and produces 0.6 V safety voltage when there are no keep-alive signals. The expected safety voltage of a string of TS4s is:

$$\text{<number of TS4-F in the string> } \times 0.6 \text{ V}$$

Test Safety Voltages

Before testing, make sure each inverter, MPPT, and physical string is properly labeled to match their “As Built” plan numbers.

To test a string’s safety voltage:

1. Power-off all transmitters using PLC.
2. Switch off each inverter’s AC and DC sides.
3. Open or remove the fuse for each string input to the inverter.
If the inverter has no fuses, disconnect each string from the MPPT inputs for direct measurement.
4. Record the inverter #, MPPT #, string #, and expected safety voltage in the measurements table.
5. Measure and record the string’s actual safety voltage in the measurements table.
6. Compare the recorded safety voltage to the expected safety voltage.

The string’s actual voltage should be within 1% of the expected safety voltage. If not, mark the table’s *Error?* column.

Resolve Safety Voltage Errors

Resolve all errors marked in the table before proceeding to powered string measurements.

If the measured safety voltage does not match the expected voltage, make sure that:

- If the measured safety voltage is 0 V, the string’s fuse is open: the TS4s must be unloaded to produce 0.6 V. Make sure all fuses of adjacent strings in the MPPT are open.
- All TS4 input cables are connected to solar modules and not strings.
- TS4 output cables are properly connected to each other.
- The string is properly crimped and connected to the first and last TS4s.

If the measured safety voltage exceeds the expected voltage:

- Make sure that all string fuses are open to ensure that string safety voltages are not connected in parallel with each other.
- If the safety voltage is >30 V, make sure that a solar module is not connected directly to a string without using a TS4.

Powered String Measurements



CAUTION!

Resolve all unpowered string issues before powering up the rapid shutdown system and performing powered measurements. Powering on a mis-wired, or defective system may damage equipment and invalidate MLPE and inverter warranties.

For powered string measurements, use a voltmeter rated for 1,000 V for commercial rooftop installations and a 1,500 V rating for commercial ground mount installations.

Measure Open Circuit Voltage (V_{OC})

Use V_{OC} measurements to check for reasonable operation. Irradiance and temperature affect results. Measuring the V_{OC} of a solar module disconnected from a TS4 at the time of testing will be more accurate than using the module's V_{OC} rating from a datasheet. Taking the average module V_{OC} from a string of modules is also useful.

The expected V_{OC} of a string is:

$$\text{<number of modules in the string> } \times \text{ <single module's } V_{OC} \text{ measurement or rating>}$$

To set up V_{OC} measurement:

1. Open all string fuses of all MPPTs for all inverters.
If there are no fuses, ensure all strings are labeled and disconnect them from all inverters.
2. Turn on the DC side of an inverter.
3. Turn on the inverter's RSS transmitter(s) by activating the AC initiator or by turning on the AC side of the inverter.

Inverters will not draw current from an MPPT for the first few minutes after initiating operation.

4. If the inverter begins power production, restart the inverter's AC side until all V_{OC} measurements are complete.

The open circuit string voltage (V_{OC}) can be measured only before the inverter starts producing power.

To measure string V_{OC} :

1. If fused, close one string fuse per MPPT and measure the string V_{OC} on the fuse terminal block.
If non-fused, connect a Y-branch connector to the MPPT and measure the string V_{OC} at the unoccupied Y-branch input.
Measure voltage with the negative voltmeter probe attached to the negative string terminal to check polarity.
2. Record the inverter #, MPPT #, string #, solar module count, and measured V_{OC} .
Note whether the V_{OC} is negative or positive.
3. Turn off the AC side of the inverter to restart the power production delay.
4. Open the fuse that was closed and then close the next string fuse in the MPPT.
5. Turn on the AC side of the inverter.
6. Repeat this process until all inverter strings are measured and recorded.
7. Turn off the AC side of the inverter and repeat the process with the remaining inverters.

To determine problematic V_{OC} measurements:

1. Check for negative V_{OC} measurements and mark them as errors.
2. For each inverter, compare the measurements of strings that have the same number of solar modules.
If strings have different solar modules counts, determine the V_{OC} per module and multiply that by the typical number of solar modules counts.
3. Considering different temperature and light conditions when the strings were measured, identify strings that have significantly different measurements and mark them as errors.
Examining one inverter at a time limits time and temperature differences between string V_{OC} measurements.

Resolve V_{OC} Errors

1. If V_{OC} is 0 V, make sure the fuse has not blown and is closed.
2. If the V_{OC} measurement is negative, cut the connectors off the home run and re-crimp with the opposite polarity.
3. If the V_{OC} is higher than expected:
 - Make sure all other strings connected to the MPPT have open fuses or are disconnected so that a string's V_{OC} is isolated from parallel strings.
 - Physically count the solar modules in the string and verify they match the As Built plan. Update the plan if needed.
4. If V_{OC} is lower than expected:

- Check for proper TS4-to-module connections.
- Test and replace each TS4 as needed.
- Improperly connected TS4s that have been powered on may be damaged. Refer to the Help Center Testing Methods for Tigo Flex MLPE Systems article for details.

Test Current Direction



CAUTION!

Measure and resolve all V_{OC} errors before proceeding with current measurements. V_{OC} polarity must be correct before measuring current direction.

Test if all strings have the same current polarity. Reversed current may indicate improper wiring, damaged TS4s, mismatched solar modules, poor RSS signal strength, crosstalk, etc.

To test current direction:

1. Turn off the inverter's AC and DC sides and power-off any transmitters using PLC.
2. Close all string fuses.
3. Switch on the AC and DC sides to the inverter and power-up the transmitter.
4. Wait for the inverter to start producing power.
5. Clamp an amp/current meter on a positive home run string with the display facing away from the inverter.

Make sure the current meter is clamped consistently with the same orientation for each string.

6. Measure and record the measured current in the measurement table.

Note if the current is positive or negative.

7. When all measurements are complete, switch off the AC and DC sides of the inverter.

Measurements should all be similar in polarity and magnitude. If 5 strings show 10 A and one shows 5 A, mark this as an error. If a string shows a negative current, mark this as a current polarity error.

Resolve Current Direction Errors

1. Ensure only one RSS transmitter is producing an RSS signal by turning off all other transmitters.

If this remedies the problem, make sure positive and negative string conductors are within 2.54 cm (1 in.) of each other. A home run conductor must be adjacent TS4 output cables as they are daisy-chained together.

2. Using a handheld temperature gun, measure the temperature of a TS4 that is close to a nearby string that does not have reverse current.
3. Using this temperature as a baseline, measure the temperature of each TS4 in the string with reverse current.
4. Replace any TS4s that have a significantly higher temperature.
5. Using the [RSS Signal Detector](#), check for a signal at each TS4.

If absent:

- Make sure the transmitter voltage is 12 V.
- Check the polarity of the cores.
- If the home run length is greater than 300 m and less than 500 m, use two cores.
- Make sure positive and negative string conductors are within 2.54 cm (1 in.) of each other. A home run conductor must be adjacent TS4 output cables as they are daisy-chained together.

Crosstalk Measurements

Crosstalk can interfere with the keep-alive signals received by a TS4-F. Crosstalk should always be addressed to minimize the risk of substantial power loss, especially if one or more transmitters on an installation are not synchronized with the others. For more information about this kind of interference, refer to [Appendix A – Crosstalk](#).

The effects of crosstalk will differ throughout various times of the day. If inverter monitoring shows abrupt power fluctuations, this is a symptom of crosstalk.

You may test for crosstalk in parallel with V_{OC} tests.

Test for Crosstalk

To test for crosstalk with transmitters directly powered by the inverter:

1. Power-off all RSS transmitters, close all DC fuses (if used), and turn on the DC side of all inverters.

This will power-off all RSS transmitters. In the absence of crosstalk, TS4s will produce a safety voltage that is shorted out to 0 V by the inverter.

2. Power-on one of the RSS transmitters.

3. Check the MPPT voltage (either V_{OC} or V_{MP}) for strings that should have an RSS signal to verify proper operation.

It can take several minutes before an inverter scans the MPPT and begins producing power.

4. To speed up the process, check the inverter's power production.
 - If it is 0 kW, move to the next inverter.
 - If it is >0 kW, look for the MPPTs producing power and then narrow the search to individual string power production by measuring V_{MP} .

Time must be given for inverters to scan their MPPTs. It is preferable to do this test when the solar panels can produce enough current for the inverter to produce power.

5. Measure the voltage of each MPPT in inverters with unpowered transmitters.

If there is a measurable voltage, mark the source and destination inverter #s and MPPT #s as experiencing crosstalk in the error column of the measurement table.

6. Switch off the AC side of the inverter along with its RSS transmitter and then switch on the AC side of the next inverter in the sequence along with its associated RSS transmitter.

Make sure that only one inverter has the AC side and transmitter on at a time.

7. Repeat the process until all strings are tested.

To test for crosstalk with transmitters powered independently of the inverter:

1. Turn on the AC side of all site inverters, close all DC fuses (if used), and turn on the DC side of all inverters.
2. Turn on a single transmitter for the first inverter.
3. Check the MPPT voltages (either V_{oc} or V_{MP}) for strings that should have an RSS signal to verify proper operation.

4. It can take several minutes before an inverter scans the MPPT and begins producing power.

5. Measure the voltage of each MPPT in inverters with unpowered transmitters.

If there is a measurable voltage, record the source and destination inverter #s, MPPT # as crosstalk in the error column of the measurement table. This can be done via a power production display, access point, or cloud-based website.

6. To speed up the process, check the power production of the inverter.

If it is 0 kW, move to the next inverter. If it is >0 kW, look for the MPPTs producing power and then string power production.

Note that time must be given for inverters to scan their MPPTs. It is preferable to do this test when the solar modules can produce enough current for the inverter to produce power.

It is also possible for crosstalk from transmitter A to affect inverter B while transmitter B may not affect inverter A.

7. Power off the RSS transmitter and power up the next RSS transmitter in the sequence. Make sure only one transmitter is powered at time.
8. Repeat the process until all strings are tested.

Resolve Crosstalk Problems

1. Check that all RSS transmitter cores:
 - Have only the negative home run conductor passing through them.
 - Are properly aligned with the white side facing the inverter and the black side facing the array.
 - Have correct wire connections at the bottom of the transmitter with the white pin connecting to the white terminal and the black pin connecting to the black terminal.
2. Check the strings:
 - <300 m long has only one transmitter core driving them.
 - >300 m and <500 m long has two properly aligned cores.
 - No strings are longer than 500m.
3. Adjust the layout of each string so that:
 - Positive and negative home run conductors are always within 2.54 cm (1in.) of each other. A home run conductor must be adjacent TS4 output cables as they are daisy-chained together.
 - Home run conductors do not form a large loop.
 - Conduits do not contain home runs from different transmitters.
 - Conductors powered by different transmitters are at least 200 mm (8 in). apart.
 - Excess home run wire is trimmed and not spooled or wound up into a pile.
4. If transmitter A is causing inverter B to produce power, reduce the input voltage of transmitter A. If the crosstalk disappears on inverter B, double check the signal strength of every TS4 associated with inverter A to make sure there are no issues with signal strength.

Resolve Transmitter Errors

RSS transmitters use Tigo Pure Signal™ technology to mitigate crosstalk by synchronizing RSS signals in a fashion that enhances signal strength.

Carefully check that all transmitters are connected correctly according to the [Connect Signal Wiring](#) section in this manual. If problems persist, visit the Tigo [Help Center](#).

RSS Signal Detection

You can check the strength of RSS keep-alive signals with the Tigo RSS Signal Detector (Tigo Part #400-00900-00) that senses an RSS signal on a home run, at a transmitter core, or at a TS4.

To check for an RSS signal:

1. Turn on the detector.
2. Place the detector sensor area within 5 cm (2 in.) of a TS4.
 - If the detector senses a keep-alive signal at the TS4, the LED will change from blue to yellow and emit an audible alert.
 - If it detects no signal, the LED will remain blue and there will be no sound.

Multi-factor Rapid Shutdown

Multi-factor rapid shutdown (MFRS) systems provide an additional layer of protection for rapid shutdown signals with solar installations and are unique to the TS4 family. MFRS applications use two distinct rapid shutdown signals to meet rapid shutdown code: Power Line Communication (PLC) and wireless communication.

- PLC (Wired): This method uses the existing electrical wiring to send a heartbeat signal from a transmitter to each rapid shutdown device.
- Wireless: This method uses a wireless heartbeat signal from the CCA, via Tigo Access Points to each rapid shutdown device.

In both instances, when the heartbeat signal is lost, the TS4 devices go into shutdown mode and reduce voltage at the module-level, ensuring that the conductors in the array are at a code compliant level. See simple schematic below.

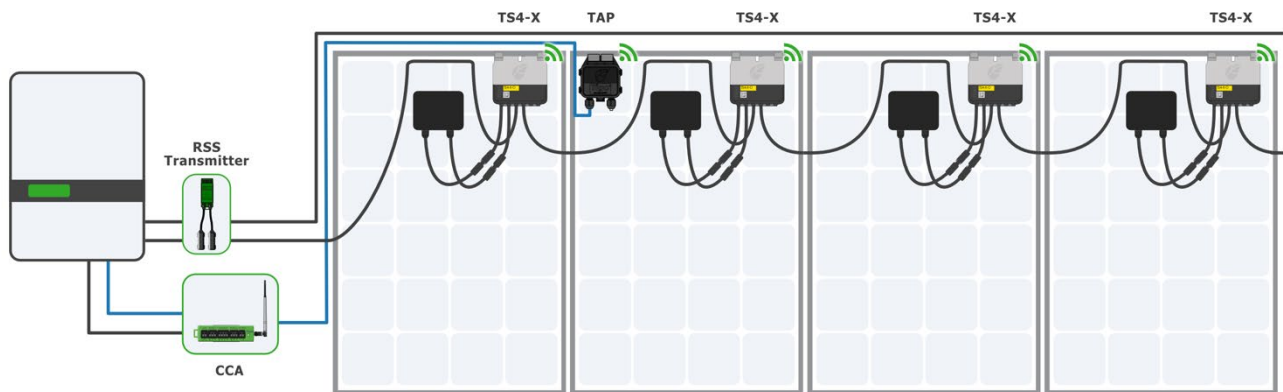

Note: MFRS is only available for TS4-O and TS4-S models. TS4-F units must be upgraded to TS4-S units to be part of a MFRS system.

For assistance with upgrading from TS4-F to TS4-S, please reach out to our [support team](#).

MFRS System Design

To initiate rapid shutdown of a PVRSS-compliant system, you must simultaneously turn off power to the Tigo CCAs, RSS Transmitters, and PV inverters using an approved initiator according to NEC 690.12(C).

Turning off the rapid shutdown initiator for PV inverters with integrated Tigo equipment fulfills this requirement.

**CAUTION!**

RSS Transmitters and CCA's use different power supplies. See requirements below.

RSS Transmitter power supply: Power supplies must reliably output 12 V ($\pm 2\%$) 1 A current for a single transmitter and 12 V ($\pm 2\%$) 10 A current for multiple (up to ten) transmitters

CCA power supply: For systems with 2 TAPs or fewer, the DC power supply may be a Tigo power supply, or a 3rd-party power supply with 12-24V DC, 1A output. For systems with 3 TAPs or more, the DC power supply must be a 24V DC, 1A output.

Non-hybrid inverter systems

The Tigo CCA and RSS Transmitter must be on the same AC branch circuit as the PV inverter to comply with rapid shutdown directives.

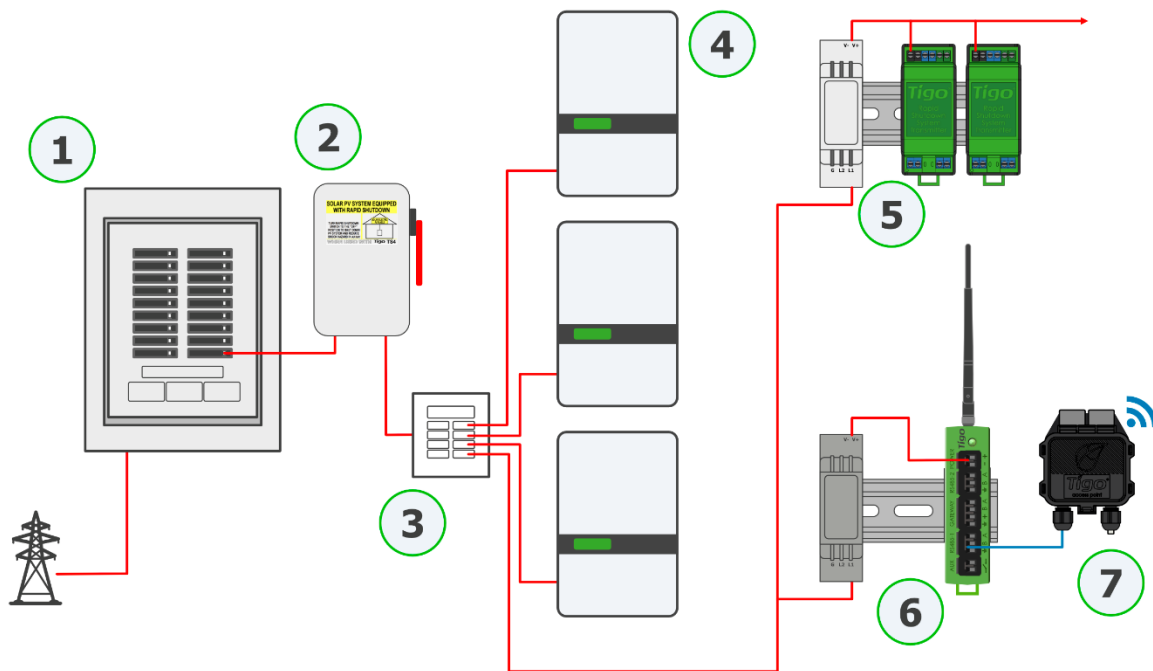

Components:

1. Electrical main panel
2. AC disconnect / rapid shutdown initiator (RSI)
3. Electrical sub-panel
4. Inverter
5. RSS Transmitter and power supply
6. Cloud Connect Advanced (CCA) and power supply
7. Tigo Access Point (TAP)

Hybrid Inverter Systems (DC-coupled energy storage systems)

Unique requirements must be met for Energy storage systems (ESS) using a hybrid inverter to provide backup power during a grid failure. You must ensure the rapid shutdown initiator turns off the CCA, RSS Transmitter, and hybrid inverter.

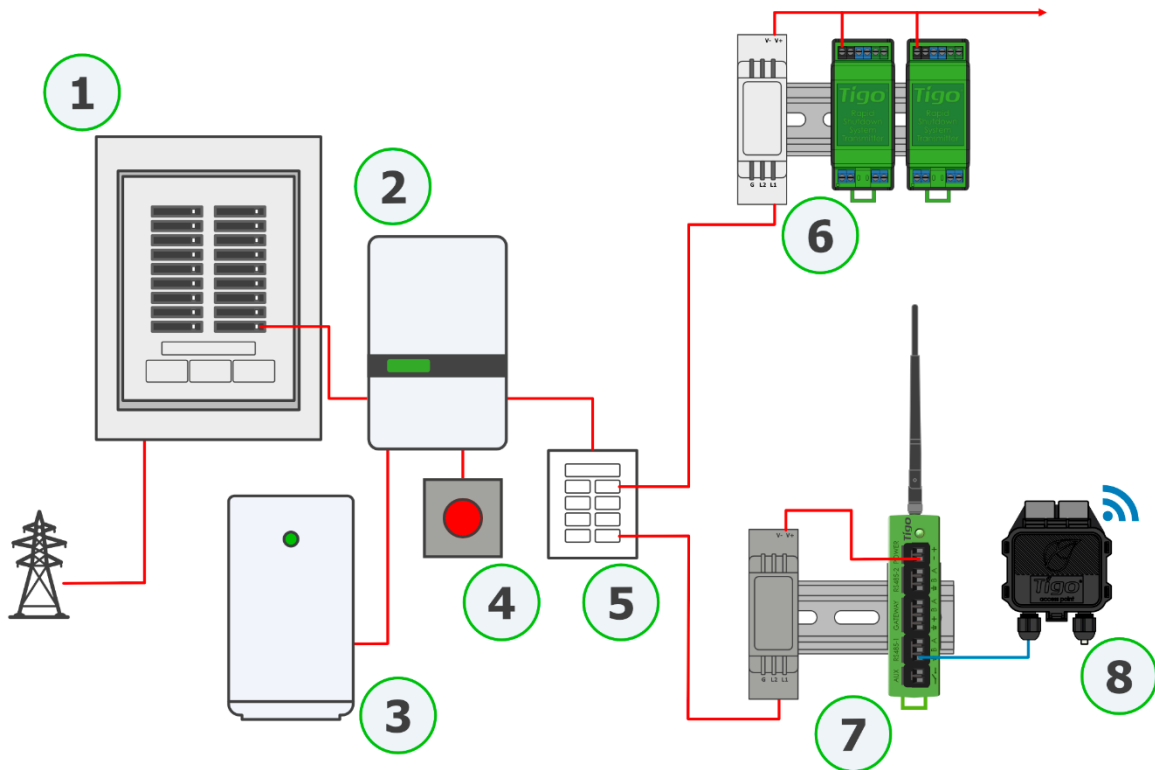

Components:

1. Electrical main panel
2. Inverter
3. Battery
4. Rapid shutdown initiator / e-stop
5. Backup panel
6. RSS Transmitter and power supply
7. Cloud Connect Advanced (CCA) and power supply
8. Tigo Access Point (TAP)

Consult the Tigo documentation for wiring diagrams or contact Tigo Customer Success if you have any questions.

Specifications

Download comprehensive specifications for all Tigo products from the Tigoenergy.com [Downloads](http://www.tigoenergy.com/downloads) (www.tigoenergy.com/downloads) page.

Warranty

Download comprehensive warranty information from the Tigoenergy.com [Downloads](http://www.tigoenergy.com/downloads) (www.tigoenergy.com/downloads) page.

Support

If you have any questions about installing or maintaining Tigo equipment, visit the [Tigo Help Center](#), email support@tigoenergy.com, or call:

- North America (7 a.m. to 6 p.m. Pacific Time): +1 408 402-0802
- South America (Brazil): +55 21-991045050
- Europe: Phone: +39 055 1987 0059 (Italian, English, German, Polish, Spanish)
- Middle East: Phone: +972 50 687-8618
- Japan: +81 3 4567-6199
- China: +86 512 6587-4600
- Taiwan: +886 919 743-749
- Australia: +61 2 5700 834