



User Manual

V Series



LITHIUM ION BATTERIES



Pytes V Series LFP Battery User Manual

Dear valued customer,

Thank you for purchasing our Pytes V series LFP battery for home energy storage system. Our V series battery pack is designed to provide safe, high-performance energy storage solutions for a variety of applications. The compact and easy-to-install battery pack can be used as a basic building block in an energy storage system by connecting in parallel. It is widely used in residential, small commercial, and industrial energy storage systems, as well as telecommunication stations.

We strongly recommend that you carefully read this manual before using the product. This manual provides all the necessary information on installation, usage of the V series battery pack. Please be advised that only qualified personnel (such as an electrician) should install and perform maintenance on the battery pack.

It is important to keep in mind the boundaries of use, as described in this manual. The V series battery pack is not intended for use in medical or aviation-related applications, and should only be used for its intended purpose as described in this manual. Improper use of the battery pack will void the warranty of the product, and Pytes cannot be held responsible for any damage caused by improper or incorrect use of the product.

For your safety and the safety of others, please follow all user safety instructions during the use of this product. This manual is intended for the installers and users of the V series battery pack.

Please keep this manual in a safe location, as it is the original manual. For the latest version of all manuals, please visit our website at <http://www.pytesgroup.com>.

Thank you again for choosing Pytes, and please do not hesitate to contact us if you have any questions or concerns about your V series battery pack.

Best regards,

Pytes

Shanghai Pytes Energy CO., LTD.

Add: No.3492 Jinqian Road, Fengxian District, Shanghai, China.

Website: <http://www.pytesgroup.com>

Email: ess_support@pytesgroup.com

Before Using

Please read and follow these instructions carefully:

Warning

This equipment should only be installed, operated by qualified personnel (electricians). The local safety regulations and relevant operating procedures must be followed during the installation, operation and maintenance of the equipment, otherwise the equipment may be damaged. The safety precautions mentioned in this manual are supplementary to the local safety regulations.

Caution

Do not short-circuit the Li-ion battery.
Follow the positive (+) and negative (-) marks on the Li-ion battery and equipment and ensure correct use. Do not reverse the Li-ion battery.
Do not dismantle, crush, puncture, open, or shred the Li-ion battery.
Before removing or reconnecting with the running system, make sure to turn off the power and shut down the system to avoid the risk of electric shock.
Do not expose the Li-ion battery to heat or fire. In case of fire, use a dry powder fire extinguisher.
Do not dismantle any part of the system without contacting PYTES or PYTES authorized technical engineers. System failure caused by such actions will not be covered by the warranty.
Before operating the inverter, ensure that all batteries have been started up.
The following precautions should be taken when working on batteries:









- Shut down the power and loads before connecting or disconnecting battery terminals.
- Do not wear any metal objects such as watches and rings.
- Use tools with insulated handles.
- Do not lay tools or metal parts on top of batteries.
- Wear personal protective equipment.
- Make sure the battery is well grounded. Contact with any part of a poorly grounded or ungrounded battery can cause electric shock and burns by high short-circuit current.

The battery should be charged within 12 hours when it's fully discharged or over-discharging protection mode is activated. Failure to follow this instruction will damage the battery and is not covered by warranty.

Danger

Do not dispose of batteries in fire, as the batteries may explode.
Keep the Li-ion battery away from water, dust, and contamination to avoid explosion or other harmful conditions that may even lead to personal injury.
Do not open or mutilate batteries. Released electrolyte can be harmful to the skin and eyes and may be toxic.
A battery can pose a risk of electric shock and burns due to high short-circuit current.
A malfunctioning battery can reach temperatures that exceed the safe contact level.

Symbols

	Read the instruction manual before starting installation and operation.
	Caution, do not dispose of batteries in a fire, the battery may explode.
	caution, a battery can present a risk of electric shock and burns by high short-circuit current. do not short-circuit the Li-ion battery.
	Caution, do not dispose the product with household wastes.
	Danger, keep the Li-ion battery away from water, dust and contamination, otherwise it may cause explosion or lead to personal injury.
	Danger, do not place near open flame or flammable materials.
	Danger, do not place at children or pets touchable areas.
	Recyclable.

CONTENTS

1 Specifications	6
1.1 Product standard configuration	7
1.2 BMS function	8
2 Interface and protection functions	9
2.1 Battery front panel schematic	9
2.2 Components	10
3 Operating Environment	11
4 Packaging, transportation, storage requirements	11
4.1 Transportation	11
4.2 Storage	11
4.3 Disposal	11
5 Installation and configuration	11
5.1 Installation preparation	11
5.2 Unpacking	12
5.3 Installation	13
5.4 Procedure of starting/Shut down the whole system	15
6 Communication	15
6.1 RS232 port	16
6.2 RS485 port and CAN port	16
7 Troubleshooting	16
7.1 Unable to start	17
7.2 Unable to charge	17
7.3 Unable to discharge	17
7.4 ALM constantly on	18

1 Specifications

Table 1-1 Battery Pack Specifications

Battery Model	V5°	V5°α	V5°α Plus
Power Terminal	PHOENIX M6 Bolt	Amphenol SurLok Plus 8.0mm	
Chemistry	LFP		
Nominal Voltage	51.2V		
Voltage Range	47.5V~57.6V		
Nominal Capacity	100Ah		
Nominal Energy	5.12kWh		
Unit Dimension	L442mm*W530mm*H140mm(3.2U) L17.40in*W20.87in*H5.51in(3.2U)	L484*W578.2*H140mm(3.2U) L19.05*W22.76*H5.5in(3.2U)	
Unit Weight	44KG / 97lbs		45.34KG / 100lbs
Recommended Charge/ Discharge Current ^[1]	75A		
Max Charge/ Discharge Current ^[2]	100A		
Peak Charge/ Discharge Current	101A~120A (3min) 121A~180A (15sec)	101A~120A (3min) 121A~200A (15sec)	
Round-Trip Efficiency	≥95%		
Communication Protocol	RS485, CAN, WiFi (W/ Optional Device)		
Cycle Life ^[3]	≥6000cycles		
Calendar Life	≥10years		
Operating Temperature	Charge: 0°C~45°C(32°F~113°F) Discharge: -10°C~50°C(14°F~122°F)		
Certificates	UN38.3, CE, UL1973, UL9540A, UL9540, IEC62619, CEC, SGIP		
Storage Temperature	Within 1month: -20°C~50°C(-4°F~122°F) 1-3months: -10°C~40°C(14°F~104°F) 3-12months: > 0°C~30°C(32°F~86°F)		
Heating System ^[4]	Temperature Rise 10°C(18°F)/Hour, Operation Temperature -18°C~10°C(-0.4°F~50°F)		

[1], [2]: The recommended and Max continuous charge and discharge current is for a battery cell temperature within 10°C~40°C(50°F~104°F)to consider. It will result in a derating on current if out of the temperature range.





[3]: Test conditions 0.2C Charging/Discharging, @25°C(77°F), 90% DOD.

[4]: Optional Device. Specified on Battery package whether integrated.

Working with some inverters, heating system may consume energy from battery when there's voltage difference among system modules, between 0°C/32°F to 5°C/41°F. Follow 5.3.3 of this manual for multiple batteries power cable connection to minimize influence of the circular current, thus decrease battery energy loss.

1.1 Product standard configuration

V5° Version

Items	Quantity	Specifications	Pictures
V5° Battery	1pc	LFP battery pack Voltage: 51.2V Capacity: 100Ah Energy:5.12kWh Power Terminal: PHOENIX C-ES-FTB 25-70	
Flexible Busbar	2pc	Busbar for parallel connection between batteries: Length: 190mm/Ampacity: 300A	
Cascade Communication Cable	1pc	Function: cascade communication between batteries Length: 350mm Communication protocols: CAN / RS485	
Grounding Cable	1pc	10AWG/1000mm/SC10-6	

V5°α Version

Items	Quantity	Specifications	Pictures
V5°α Battery	1pc	LFP battery pack Voltage: 51.2V Capacity: 100Ah Energy:5.12kWh Power Terminal: Amphenol Surlok 8.0mm Socket	
Power Cable	1set	Cable for parallel connection between batteries; UL10269-0AWG / 180mm / Amphenol Surlok 8.0mm; Ampacity: 200A	
Cascade communication Cable	1pc	Function: cascade communication between batteries Length: 350mm Communication protocols: CAN / RS485	
Grounding Cable	1pc	10AWG/1000mm/SC10-6	

V5^α Plus Version

Items	Quantity	Specifications	Pictures
V5 ^α a Plus Battery	1pc	LFP battery pack Voltage: 51.2V Capacity: 100Ah Energy:5.12kWh Power Terminal: Amphenol Surlok 8.0mm Socket	
Power Cable	1set	Cable for parallel connection between batteries; UL10269-0AWG / 180mm / Amphenol Surlok 8.0mm; Ampacity: 200A	
Cascade communication Cable	1pc	Function: cascade communication between batteries Length: 350mm Communication protocols: CAN / RS485	
Grounding Cable	1pc	10AWG/1000mm/SC10-6	

1.2 BMS Functions

Protection and Alarm	Management and Monitor
Charge / Discharge End Cut-off	Cells Balance
Charge over Voltage Protection	Intelligent Charge
Discharge under Voltage Protection	Charge/Discharge Current Limitation
Charge / Discharge over Current Protection	Remaining Power Calculation
High / Low Temperature Warning Over / Under Temperature Protection	Administrator Monitoring
Short Circuit Protection	Log Record
Power Cable Reverse Protection	

2 Interface and protection functions

2.1 Battery front panel schematic

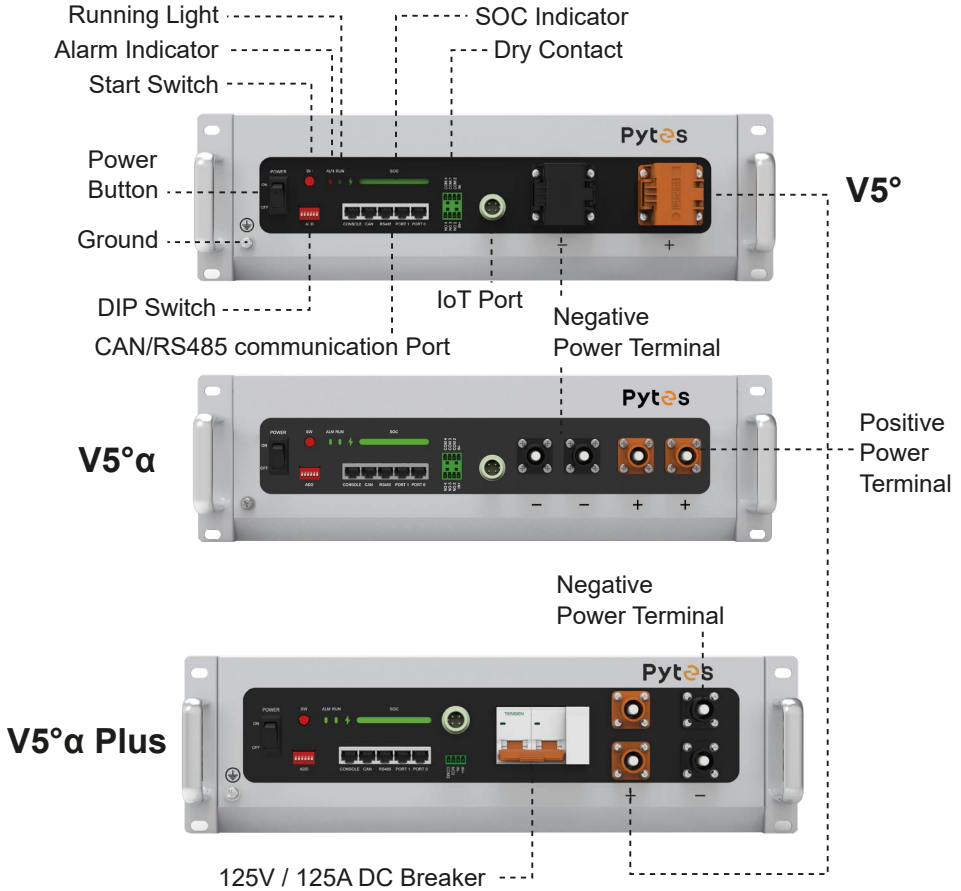

2.2 Components

No.	Name	Label	Functions description
1	Ground		Connection for ground cable
2	Power button	POWER	When switched to "ON", the system can be activated by the "SW" key or external power supply; when switched to "OFF", the system is off.
3	Soft start switch	SW	When the on/off button is "ON", press and hold this button for 1 second to enter the startup or sleep mode.
4	DIP Switch	ADD	Set according to inverter brand, see checking list
5	Running Light	RUN	Green light. The light flashes when Standby. The light is constantly on when charging. The light blinks when discharging.
	Alarm Indicator	ALM	Red light. The light flashes when Alarming. The light is continuously on when protected.
	SOC indicator	SOC	Light bar shows current remaining capacity.
6	External CAN communication port	CAN	RJ45 port, follows CAN protocol, for outputting battery information.
7	External RS-485 communication port	RS485	RJ45 port, follows RS485 protocol, for outputting battery information.
8	Cascade communication port	Prot 1/0	RJ45 ports, connect Port 1 of the previous battery to Port 0 of the next one. The Port 0 of the master battery is vacant.
9	Negative Power Terminal	"-"	Negative input and output interface
10	Positive Power Terminal	"+"	Positive input and output interface
11	Dry Contact	IN1-/IN1+ COM2/NO2 COM3/NO3 COM4/NO4	1 way input and 3 ways output dry contact signal.
12	LoT port		Real-time monitoring of battery status and remote upgrade
13	DC Breaker		Turns Power Supply on/off

⚠ Warning: 6,7,8,9,10,11,12is DVC-A circuit, they shall not be connected to DVC-B/C circuit when installed, or hazard shock will occur.

3 Operating Environment

- ◇ Battery operating environment requirements:
- ◇ Operating Temperature: -10°C~50°C(14°F~122°F)
- ◇ Relative Humidity: 20%-80%, no condensation
- ◇ Altitude: <4000m
- ◇ Site environment requirements: Away from heat source, avoid direct sunlight, no corrosive gases, no explosive gases, no insulating gases, no insulating conductive dust.
Install in cabinet which shall not be opened without dedicated tools
- ◇ Install in a restricted access area.

4 Packaging, transportation, storage requirements

4.1 Transportation

Always check all applicable local, national, and international regulations before transporting Li-ion Batteries.

During transportation, protect the battery from severe vibration, shock or squeezing, and from exposure to sunlight and rain.

During the loading and unloading process, the battery should be handled gently to prevent it from falling, rolling and being subjected to heavy pressure.

4.2 Storage

- Relative humidity: 20%-80%, no condensation
- Altitude: <4000m
- Store the battery in a cool, dry place, away from heat sources and no direct sunlight.
- Keep away from conductive substances such as conductive dust

For long-term storage (>6 months), charge the LFP battery to more than 90% of its rated capacity. The battery needs to be charged to more than 90% of its rated capacity every 6 months.

Keep the SOC of the battery at 40%-60% during storage. The Self-discharge of the LFP battery pack is 1-2% per month. If there is no power left when checking the LFP battery, do not charge or use it without permission, contact your installer for the next step.

Follow the storage instructions in this section and refer to Table 1-1 Battery Pack Specifications for storage temperature to optimize the battery lifespan during storage. Any failure or damage to the battery caused by failure of following these instructions is not covered by the warranty.

4.3 Disposal

Disposal of the batteries should be in accordance with local laws and regulations and should be carried out by an expert with specialized knowledge and experience in electrical and environmental safety, at designated waste disposal facilities using safe and appropriate method.

5 Installation and configuration

5.1 Installation preparation

5.1.1 Safety Requirements

Only those who have received training in the power system and possess a comprehensive understanding of the same are allowed to install the equipment. It is imperative to follow the safety regulations defined by local authorities and adhere to the safety requirements listed below during the installation process.

Before installing or removing the battery, make sure that the system is disconnected from any power

source and that the battery system is turned off. Distribution cabling needs to be handled carefully with essential protective measures to avoid any safety hazards during the maintenance and operation.

5.1.2 Checking the operation environment

The operation environment must comply with the requirements outlined in Chapter 3, "Operation Environment." If not, necessary adjustments must be made and subsequently reevaluated.

5.1.3 Tools

The tools that may be used are shown in Table 5-1.

Table 5-1 Tools

Tools	
Screwdriver (Slotted, Phillips)	Multimeter
Wrench	Clip-on ammeter
Diagonal pliers	Insulating tape
Thermometer	Pliers
Anti-static wrist ring	Clip Pliers
Tapes	Strippers

5.1.4 Technical preparation

Electrical interface settings:

If the battery is directly connected to the energy storage inverter or DC charger, please verify: if the operating voltage, current, and power of the equipment align with the battery parameters listed in "Table 1-1 Battery Pack Specifications".

Safety inspection:

Fire-fighting equipment such as portable dry powder fire extinguishers in proximity to the battery is mandatory. Dangerous substances such as flammable or explosive materials must not be stored near the battery.

5.2 Unpacking

- ◇ When the battery arrives at the installation site, it must be unloaded and stored properly and prevented from the direct sunshine and rain. Before installation, check if there is any component missing according to 1.1 product standard configuration and check whether the box appearance is intact;
- ◇ Carefully handling the unpacking to preserve the insulation coating on the casing's surface.
- ◇ Please contact PYTES if there is any damage or missing of products and / or components.

5.3 Installation

5.3.1 Install the battery

The V series can be installed either vertically or horizontally. The instructions in this chapter are only for horizontal installation, while vertical installation follows a similar process. All equipment must be placed steadily after installation.

5.3.2 Connect Ground cable

Loosen the screw on the grounding position of the front panel of the battery and attach the lug of the ground cable over the screw. Use a screwdriver to tighten the screw and connect the other end of the ground cable to a reliable grounding point.

⚠ Note: The grounding resistance should be less than 0.1Ω .

5.3.3 Connecting the power cable

Before connecting the power cable, connect and disconnect the cable to identify the positive and negative terminals, then make a mark respectively. After the cable is connected, measure whether there is short-circuit or reverse connection.

Select the correct cable based on your loads by referencing to the table below :

AWG	Area		Standard Current	Max. Current
	(kcmil)	(mm ²)	(A)	(A)
4/0	211.48	107.22	423.2	482.6
3/0	167.67	85.01	335.5	382.6
2/0	133	67.43	266.2	303.6
1/0	105.5	53.49	211.1	240.7
1	83.65	42.41	167.4	190.9
2	66.31	33.62	132.7	161.3
3	52.6	26.67	105.2	120.0
4	41.7	21.15	83.5	95.2

Please select suitable power cable according to maximum current that may pass through the circuit. If you need advice, please contact your installer for help.

Connecting the power cables:

1) Power cable connection instructions of Single-Rack:

◇ **Single battery:**

Connect the positive and negative terminals of the battery to the battery port of the energy storage inverter with power cables.

◇ **Multiple batteries (Max number 16):**

The connection of multiple batteries is only permitted in parallel. Firstly, connect the positive and negative terminals of the batteries in parallel with the supplied flexible busbar (for up to three batteries, no additional accessories are required). Next connect the positive and negative terminals of the battery port of energy storage inverter to one of the batteries with power cables. But due to limitations in battery communication and power cables, a maximum of 16 batteries can be connected in parallel, and a busbar or junction box should be used for convergence.

Regardless of the number of batteries in parallel, the standard charging and discharging current for a single battery remains the same, please refer to "Table 1-1". The capacity can be increased by connecting the batteries in parallel, but due to the limitations of BMS and power cable, a maximum of 16 batteries can be connected in parallel and a busbar or junction box should be used for confluence.

⚠ Warning: Connecting batteries in series is forbidden, as it can create a high voltage that poses a hazardous shock risk.



Figure 5-1 Schematic diagram of power cable connection

⚠ Note: When multiple batteries are connected in parallel, in order to minimize the influence of the circular current, each battery can be connected to a busbar with power cable. The length, thickness, material, and resistance of the cables connected in parallel must be the same.

⚠ Warning: Batteries connected in series are forbidden, high voltage would lead to hazard shock.

2) Power cable connection instructions of Multi-Rack:

Connect the overall power cables of each rack to the convergence bus bar (or junction box) in parallel, then connect them to the energy storage inverter.

It is recommended to add a circuit breaker for protection between battery system and inverter. Rated voltage $U \geq 60V$ DC; Rated current to consider maximum DC current on inverter side.

5.3.4 Connecting communication cables

1) Communication cable connection instructions of Single-Rack:

◇ **Single battery:**

Select the corresponding port based on the communication protocol between the battery and energy storage inverter (RS485/CAN), and then insert the communication cable into the port.

◇ **Multiple batteries (Max number 16):**

The communication between the master and the slaves is carried out in a cascade mode, wherein one battery acts as the master while the others are slaves. Please refer to the picture below for the cascade connection. Users need to insert the communication cables into the relevant link ports between the batteries and keep in mind that:

1. Keep the master Port 0 free;
2. Keep the end slave Port 1 free;

Figure 5-2 Schematic diagram of communication cable connection

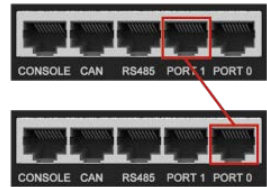

2) Communication cable connection instructions of Multi-Rack:

Connect the master battery of each rack to a hub with a standard communication cable. A Hub is required for to build up the communication between inverter and battery (more than 16 batteries or more than one rack)

⚠ Note: The system may not be able to communicate if not followed the instruction.

5.3.5 WIFI Connection

The battery provides a WiFi port for data collection and upload to the monitoring cloud platform, which supports remote viewing of battery data and enables remote firmware upgrades. This product can be purchased separately from PYTES authorized resellers/distributors/installers.

1)Diagram

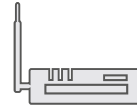

Router



Cloud

2)Connecting steps:

Step 1: Insert the WiFi stick into the LoT Port on the battery panel.

Step 2: Create an account on the cloud platform and bind the WiFi stick.

Step 3: Pair the WiFi stick with a wireless network (see WiFi stick user manual for details).

5.4 Procedure of starting/Shut down the whole system

Make sure that all batteries have been powered on prior to running the inverter. This is to avoid battery shock by the in-rush current of the large capacitors of the inverter.

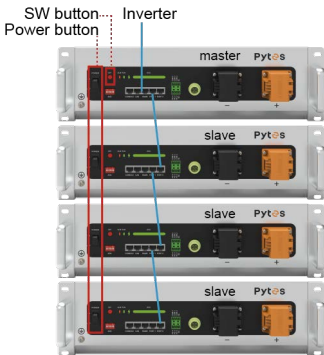

Power on Procedure

Step 1: Turn on DC Breaker of all batteries (V5°a Plus).

Step 2: Turn on all power buttons.

Step 3: Press only the master battery SW button for one second. Please ensure that all batteries have been activated before turning on the inverter.

This will help prevent battery shock caused by the inrush current of the large capacitors in the inverter.

Shut down Procedure

Step 1: Press and hold the SW button of the master battery for three seconds.

Step 2: Turn off all power buttons.

Please wait for all battery lights to go out before turning off the power buttons.

Step 3: Turn off the DC Breaker(V5°a Plus).

⚠ Note: Batteries must be placed in a locked cabinet or room with a 25mm/1inch horizontal gap for ventilation between them. The battery cabinet needs to support the total weight of the batteries and necessary accessories.

---End of installation---

6 Communication

The battery features RS-232C, RS-485, and CAN communication ports. The battery status can be obtained.

CAN

The CAN communication terminal (RJ45 port) follows CAN protocol, to output batteries information.

RS485

The RS485 communication terminal (RJ45 port) follows RS485 protocol, to output batteries information.

RS232

The RS232 communication terminal (RJ45 port) follows RS232 protocol, to upgrade the software and to communicate with your PC.

Link Port 0,1

The Port 0 and Port 1 communication terminals (RJ45 ports) follow the CAN/RS485 protocol for cascade communication between multiple parallel batteries.

LoT Port

4 Pin Circular Connector for connecting with WiFi sticks

6.1 RS232 port

Default baud rate of RS-232C ports: 115200bps.

Table 6-1 RS232 Connector Pin Assignments

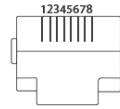

Pin number	RS-232C port
1	
2	
3	RXD
4	GND
5	
6	TXD
7	
8	

6.2 RS485 port and CAN port.

Default baud rate of RS-485 port: 9600bps

Default baud rate of CAN port: 500K

Table 6-2 RS485 and CAN Connector Pin Assignments

Pin number	Serial	CAN
1	RS485B	
2	RS485A	
3	GND	
4		CANH
5		CANL
6	GND	
7	RS485A	
8	RS485B	

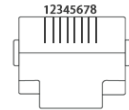

7 Troubleshooting

Please refer to the troubleshooting methods mentioned below. Please read the "Table 7-1 LED indication" of this manual before troubleshooting to avoid false operations.

For example, the blinking or constant red light of the ALM alarm on the front panel does not necessarily indicate a faulty battery. In most cases, the "alarm" indication signifies normal operation and requires no troubleshooting. Furthermore, if the battery indicates "protection," it will resume normal operation automatically once the "protection" status is released.

Table 7-1 LED indications

Battery status	Protection / Alarm / Normal	ALM	RUN	Capacity LED	Descriptions
		●	●		
Shut down		OFF	OFF	OFF	All off
Power-on	Normal	ON	ON	ON	All lights stay on simultaneously for one second
Standby	Normal	OFF	Blink 1	OFF	standby
	Alarm	Blink 3	OFF	OFF	Low voltage
Charging	Normal	OFF	Light	Base on capacity	
	Alarm	Blink 3	Light		
	Protection	Light	OFF	OFF	Protection triggered, charging stops
Discharge	Normal	OFF	Blink 3	Base on capacity	
	Alarm	Blink 3	Blink 3		
	Protection	Light	OFF	OFF	Protection triggered, discharging stops

! Note: The blinking descriptions: Blink 1 "0.3s on/3.7s off"; Blink 2 "0.5s on /0.5s off"; Blink 3 "0.5s on / 1.5s off"; Blink 4 "0.7s on / 9.3s off"

7.1 Unable to start

Problem	Troubleshooting Steps	Solution
Press the POWER button to the "ON" state and press the SW button for 1 second, but the LED indicator doesn't respond or all the LEDs are off after this 1s duration	<ol style="list-style-type: none">1. Confirm that the POWER button remains in the "ON" state;2. Charge the battery correctly and observe if the battery can be charged properly.	<ol style="list-style-type: none">1. If the battery enters into charging mode, it should return to its normal state after completing the charging process.2. If not, please contact the local reseller or Pytes.

7.2 Unable to charge

Problem	Troubleshooting Steps	Solution
The not fully charged battery cannot be charged properly.	<ol style="list-style-type: none">1. Confirm that the battery is turned on;2. Inspect the power cable to make sure that it is correctly plugged in and that the charging circuit is functioning properly;3. Check the battery indicator LED to determine if the battery is under "Protection" state. If so, unplug the battery power cable, find the cause of the protection, and correct the issue before restarting the battery.4. Ensure that the charging voltage meets the battery's charging requirements. If not, adjust the power supply voltage to the proper range.	If the battery still does not charge properly after following the steps, please contact the local reseller or Pytes.

7.3 Unable to discharge

Problem	Troubleshooting Steps	Solution
The battery cannot be discharged properly.	<ol style="list-style-type: none">1. Confirm that the battery is turned on;2. Check the power cables to ensure that they are properly connected.3. Unplug the battery power cable and measure the battery power output voltage. If the battery voltage is too low, charge it immediately.4. Check the battery indicator LED to see if the battery is under "Protection" state. If so, unplug the battery power cables, find the cause of the protection, resolve the issue, and thereafter restart the battery.	If the battery still does not discharge properly after following the above steps, please contact the local reseller or Pytes.

7.4 ALM indicator(alarm) constantly on

When the ALM indicator is constantly red and the other indicators are off, the battery is in the “Protection” state. Once the condition that triggered protection is released, the battery will automatically return to normal operation. However, there are a few issues requiring immediate measures.

Problem	Troubleshooting Steps	Solution
The ALM indicator remains in a constant state of red, while all other indicators remain inactive.	<ol style="list-style-type: none">1. Check the power cables to ensure that they are properly connected.2. Check whether the charging voltage, charging/discharging current, battery/cell voltage and temperature meet the relevant protection conditions, and release the “protection” state to ensure that the voltage, current and temperature are within the normal working range.	If the battery protection state cannot be released, or if the ALM indicator is constantly on when the battery is properly charged after it is restarted, please contact your local reseller or Pytes.

 Warning: Do not repair the battery if no authorization from Pytes!

Warranty Card

Customer Information			
Contact Name			
Phone Number		Email	
Address			
Product Information			
Battery Model		Inverter Brand/Model	
Battery Quantity		Inverter Quantity	
Purchase Date		Inverter Using Time	
Serial Number		on/off Grid	
Installer Information			
Installer Name		Installation Date	
Problem Description			
Photos of Battery Wiring			
Photos of Inverter Wiring and Panels			



Shanghai PYTES Energy Co., LTD

Add: No.3492 Jinqian Road, Fengxian District, Shanghai, China

Tel: +86 21 5747 5852

Email: ess_support@pytesgroup.com