



## FORTRESS EVAULT 18.5 kWh LITHIUM BATTERY INSTALLATION MANUAL

### *SECURE YOUR ENERGY WITH FORTRESS LITHIUM BATTERY SYSTEMS*

Fortress battery systems utilize the industry's most environmentally benign chemistry- Lithium Ferro Phosphate, which eliminates operating temperature constraints, toxic coolants, and the risk of thermal runaway and fire. The built-in smart Battery Management System (BMS) integrates multilevel safety concepts: Overcharge and Deep Discharge Protection; Voltage and Temperature Observation; Cell balancing.

Fortress high-performance Lithium Batteries are manufactured at the highest quality standard. It comes with large power capacity and a fast charging and continuous discharge power. The proprietary architecture and BMS eliminate the need for cooling or ventilation, which creates an efficient round-trip conversion.

The Fortress Lithium Battery is safe, easy to install, consistently reliable, and highly efficient. It provides you the lowest lifetime energy cost.

This installation manual contains information concerning important procedures and features of Fortress Power Lithium batteries. Read all the instructions in this manual before installation, operation, transportation, storage and maintenance.



**Table of Contents:**

- 1. SAFETY
  - 1.1 General Safety Precautions and Safety Instructions ..... 3
- 2. TRANSPORTATION, HANDLING AND STORAGE
  - 2.1 Transportation and Handling.....4
  - 2.2 Storage.....4
  - 2.3 Response to Emergency Situations .....5
- 3 PRODUCT INTRODUCTIONS
  - 3.1 Technical Data .....5
- 4. INSTALLATION
  - 4.1 Tools and Material List for Installation.....6
  - 4.2 Inspection before Installation.....7
  - 4.3 Installation Location.....7
  - 4.4 Installation Steps.....7-10
    - 4.4.1 Mounting and Securing the Battery .....7-9
    - 4.4.2 Connecting the battery to the Charge Controller and/or hybrid inverter.....9-10
    - 4.4.3 Using RS485 and CAN Communication port.....10
    - 4.4.4 Grounding .....10
    - 4.4.5 Power up the system.....10
  - 4.5 Parallel Connection.....11-13
  - 4.6 LCD Display and Alarm Warning.....14
  - 4.7 Final Connection of the Installation.....15
  - 4.8 Turn off the unit.....15
- 5. RETROFITTING.....15
- 6. OPERATING
  - 6.1 Operating environment.....15
  - 6.2 Charging .....15
    - 6.2.1 Charging stage .....15
  - 6.3 Discharging .....16
  - 6.4 Parameter set up guide in Charger/Inverter .....16
- 7. TROUBLE SHOOTING.....17
- 8. SERVICE AND MAINTENANCE.....17

# 1. SAFETY

## 1.1 General safety precautions

- ❖ All types of breakdown of the product may lead to a leakage of electrolyte or flammable gas.
- ❖ During installation of the battery, the utility grid, solar input must be disconnected from the Battery Pack wiring. Wiring must be carried out by qualified personnel. Battery Pack is not user serviceable. High voltage or current is present in the device. The electronics inside the Battery Pack are vulnerable to electrostatic discharge. Observe the following precautions:
- ❖ Risks of explosion
  - Do not subject the battery pack to strong impacts.
  - Do not crush or puncture the battery pack.
  - Do not dispose of the battery pack in a fire.
- ❖ Risks of fire
  - Do not expose the battery pack to temperatures in excess of 122 °F.
  - Do not place the battery pack near a heat source such as a fireplace.
  - Do not expose the battery pack to direct sunlight.
  - Do not allow the battery connectors to touch conductive objects such as wires.
- ❖ Risks of electric shock
  - Do not disassemble the battery pack
  - Do not touch the battery pack with wet hands
  - Do not expose the battery pack to moisture or liquids
  - Keep the battery pack away from children and animals.
- ❖ Risks of damage to the battery pack
  - Do not allow the battery pack to come into contact with liquids.
  - Do not subject the battery pack to high pressures.
  - Do not place any objects on top of the battery pack.



**IMPORTANT NOTE:** Circuit Breakers, Disconnects and Fuses should be employed throughout several points of a power storage and generation installation to effectively isolate and protect all components of the system to safeguard against faults, short circuits, polarity reversals or a failure of any component in the overall system. Fuses, breakers, wiring ratings and values should be determined by established standards and evaluated by certified electricians, licensed installers, and regional code authorities. The Fortress Lithium Batteries must always be installed with a charge controller and the appropriate settings to protect the batteries from open PV voltage and other high voltage charging sources. The Fortress Battery Management System (BMS) alone will not protect the batteries from these extreme electrical phenomena. Failure to adhere to installation protocol will void the Warranty.



**CAUTION!** Verify polarity at all connections with a standard volt meter before energizing the system. Reverse polarity at the battery terminals will void the Warranty and destroy the batteries. Do not short circuit the batteries.

Most batteries pose some risk of shock or sparking during the installation and initial wiring and connection process. Wearing insulated gloves, clothing and footwear and using electrically insulated tools are required when working with Fortress Power Lithium Batteries. Cover, restrain or remove jewelry or conductive objects (metal bracelets, rings, belt buckles, metal snaps, zippers, etc.) when working with any electrical or mechanical device. Cover or restrain long hair and loose clothing when working with any electrical or mechanical device.



**CAUTION! Do not combine Fortress Lithium Batteries with other brands or chemistries; Do not mix Fortress Lithium Batteries from different installations, clients, or job sites.**



**CAUTION! Do not disassemble or modify the battery. If the battery housing is damaged, do not touch exposed contents.**

## 2. TRANSPORTATION, HANDLING AND STORAGE

### 2.1 Transportation and Handling

Do not knock, drop, puncture, or crush the battery; Do not expose battery to flames, incinerate or direct sunlight; Do not open battery case or disassemble the battery; Do not lift battery by the terminal cables; Do not vibrate battery; Do not expose battery to water or other fluids; Do not expose battery to open flame; Do not place the product nearby highly flammable materials, it may lead to fire or explosion in case of accident; Store at cool and dry place. (Do not store in greenhouses and storage areas for hay, straw, chaff, animal feed, fertilizers, vegetables or fruit products; Store the product on a flat surface; A ventilated area is strongly recommended for handling the product; Store the product out of reach of children and animals; Store the product where it should be minimal dust and dirt in the area; do not transport battery upside down;

### 2.2 Storage

Do not expose battery to high temperatures. Fortress Lithium Batteries should be stored out of direct sunlight under the following temperature conditions.

Storage Temperature (Min./Max.): 41°F/5°C – 95°F/35°C

Relative Humidity (Min./Max.): 5%~75% RH

Systems should be put into storage at 60% SOC and checked monthly to ensure the system SOC does not fall below 20%. At 20% SOC the battery will self-discharge in approximately 2 months. Also check the voltage every 3 months and recycle every 6 months if the battery is not use for long time.

## 2.3 Response to emergency situations

The battery pack comprises multiple batteries that are designed to prevent hazards resulting from failures. However, Fortress Power cannot guarantee their absolute safety.

### ❖ Leaking Batteries

- ❖ If the battery pack leaks electrolyte, avoid contact with the leaking liquid or gas. If one is exposed to the leaked substance, immediately perform the actions described below.
  - **Inhalation:** Evacuate the contaminated area and seek medical attention.
  - **Contact with eyes:** Rinse eyes with flowing water for 15 minutes and seek medical attention.
  - **Contact with skin:** Wash the affected area thoroughly with soap and water, and seek medical attention
  - **Ingestion:** Induce vomiting, and seek medical attention

### ❖ Fire

- In case of fires, make sure that the extinguisher is available near the battery pack. If possible, move the battery pack to a safe area before it catches fire.
 

**Note: Fire extinguisher**

  - Water, carbon dioxide, dry chemical powder and foam are the most effective means to extinguish a Lithium Ferrous Phosphate (LFP) battery fire
  - Use ABC Fire extinguisher, if the fire is not from battery and not spread to it yet.

## 3. PRODUCT INTRODUCTION

### 3.1 Technical data

Model	eVault 18.5
Total Energy(kWh)	18.5
Recommend Charge Current	100
Max. Charge Current (Continuous) [A]	170
Max. Discharge Current Continuous) [A]	180
Max Pulse Current for 10sec [A]	200
Capacity [Ah]	360
Voltage [V]	51.2 (48)
Charging Temperature [F]	32~113
Discharging Temperature [F]	32~140
Dimension [WxDxH] in Inch	19.2x21.3x38.8
Packaging Dimension in Inch	45x24x31
Connection Terminal	M8
Weight [Lb]	476
Enclosure Protection Rating	21 (indoor unit)
Scalability	Up to 12
High Current Circuit Breaker	250 A
Battery Efficiency	>98%

## 4. INSTALLATION

Safe and reliable installation requires trained and certified technicians. The following discussion of Fortress Power Battery configurations is a basic primer. Due to the variety of systems and components in the field, all possible scenarios are not covered. This is not the purpose of this section of the manual. Refer to professional installers regarding your system and its components and specifications. We encourage you or your installer to contact us with any specific questions for technical support. We are committed to working with you and your installation team to achieve a safe, reliable storage system that will provide years of maintenance free service.



**Fortress Lithium Batteries are designed for parallel operation only - do not arrange in series for increased voltage. Series arrangement can result in damage to Fortress Lithium Batteries and will void warranty!**



**Do not combine Fortress Power Battery with other brands or chemistries. Do not mix different capacity batteries, do not mix batteries from different installations, or job site.**

### 4.1 Tools & Materials

- ❖ The following insulated tools and materials are required:
  - Positive and negative battery cables. We recommend copper cables AWG 4/0 . The battery cables are not included. Please refer to the published Battery Cable Sizing Chart for the proper size, based on your system specification.
  - Positive and Negative Terminal luge recommendation: M8 (diameter: 8mm or 5/16in)
  - Conduit size recommendation: 3/4, 1& 1 ¼ inch
  - Screwdriver
  - Communication Bus Terminator: to Match Impedances during parallel setup
  - RS 485 cable & Wall Mount Brackets
  - RECOMMENDED: Small 48V Charger for trickle-charge purposes
  - OSHA approved personal protective equipment

			
Insulated gloves	Safety Glasses	Safety Shoes	Bus Terminator

## 4.2 Inspection before Installation

- ✓ Check the battery package, type, quantity, appearance and other components
- ✓ Check if there is any damage on the battery box
- ✓ Check the battery terminals and connections to make sure they are clean, free of dirt, fluids and corrosion
- ✓ All battery cables and their connections should be tight, intact, and NOT broken or frayed
- ✓ Check torque on terminal bolts
- ✓ Replace any damaged batteries and cables



**IMPORTANT NOTE:** Please inform us of any problems within 7 days of receipt of goods. Otherwise, we deem that clients have no objection to the goods.

## 4.3 Installation Location

The battery pack must be installed indoors. Make sure that the installation location meets the following conditions:

- ✓ The area is completely waterproof.
- ✓ The floor is flat and level (Inclination < 15°).
- ✓ There are no flammable or explosive materials.
- ✓ The optimal ambient temperature is within the range from 59 °F to 95 °F.
- ✓ The temperature and humidity are maintained at a constant level.
- ✓ There is minimal dust and dirt in the area.



**IMPORTANT NOTE:** If the ambient temperature is outside the operating range, the battery pack may stop operating to protect itself. Frequent exposure to harsh temperatures may deteriorate the performance and life of the battery pack.

## 4.4 Installation Steps

### 4.4.1. Mounting and securing the battery

The Fortress eVault 18.5 is designed to stand on the floor with 4 wheels on the bottom. If desired, the wheels can be disassembled. We recommend putting the batteries on durable racks to avoid flooding. Please refer to the Fortress Lithium Battery Data Sheet for weight and dimension.

### 4.4.2. Mounting the battery pack to a wall

1. Fasten the screws through the mounting brackets into the holes of the battery pack on its both sides.
2. Secure the mounting brackets to the wall with screws. Make sure to leave a space of at least 2.18 inches in between the battery pack and the wall.
3. Lock the rollers on the battery pack



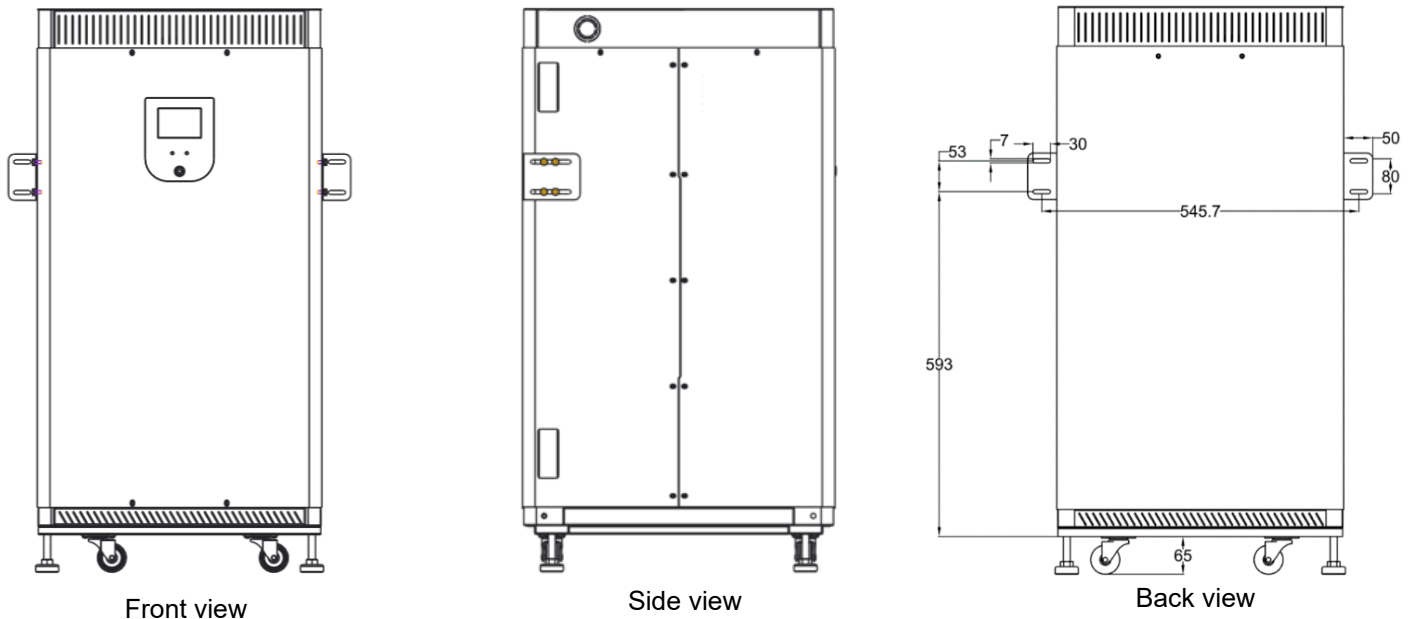

Front view

Side view

Back view

*Dimensions are in mm*

#### 4.4.3 Connecting the battery to the Charge Controller and/or Hybrid Inverter

The battery terminals are positioned under the top cover. Please use the screw driver to take the screws along the top cover off.

Please make sure the breaker near the terminal is in the OFF position. Please install the positive cable first and the negative cable second. Please do not cross the positive and negative terminals; also, ensure the terminals are not connected to any metal mounting, fixture, or body part. Recommended terminal torque is 7.0 – 7.7 Nm (5.1 – 5.7 ft-lb)

The Fortress Lithium Batteries are equipped with two M8 threaded terminals with a lock washer and nut. The right-hand stud resides in a red high temperature molded insert. This connection is for the positive lead. The left-hand stud resides in a black high temperature insert. This connection is for the negative lead. 8mm ring terminals along with proper size wiring cables are required to connect battery to inverter/charger. **Do not reverse polarity, doing so will void warranty. Use a voltmeter to check polarity before connecting terminals.**

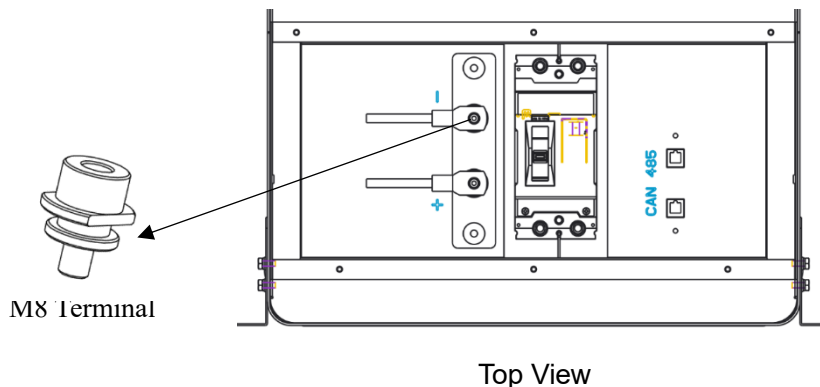

Top View





**NOTE! Without exception, products experiencing terminal burn out will not covered under the warranty.**

The knockouts are positioned on each side of the battery. The knockouts have 3 dimensions available: 3/4, 1 & 1 ¼ inch.

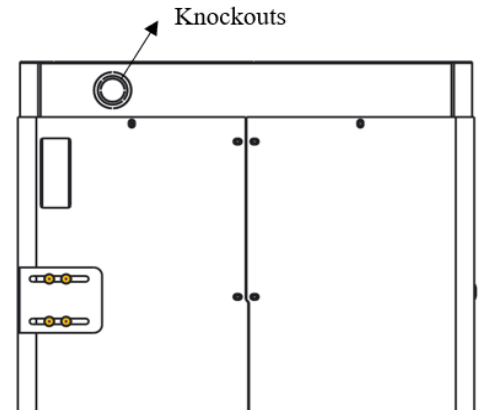

#### 4.4.3 Using RS485 and CAN Communication Port

Fortress eVault 18.5 has a self-managed Battery Management System (BMS). No communication is required between a battery-based inverter and the eVault 18.5 to operate the system.

The unit has two ports next to the battery breaker (refer to the Top View picture, page 9). Both ports are designed to support RS 485 and CAN communication.

These ports are primarily used in parallel setup (see section 4.4.6.)

These ports also support MODBUS communication. Please consult with Fortress Technical Support for further assistance



**CAUTION! Please check with Fortress Power to see if you can use the CAN comm. port to connect the battery to your charge controller or battery-based inverter.**

#### 4.4.4 Grounding

Grounding the battery, if necessary. Fortress eVault 18.5 has 4 grounding holes on the bottom of battery case.

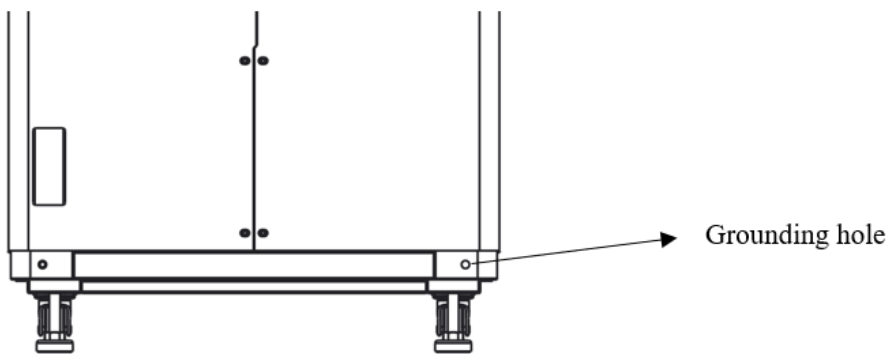

#### 4.4.5 System Commission

If you're only installing (x1) eVault 18.5, please follow the below steps to start up the system.

1. Check system connection cables for correct polarity.
2. Put the battery's 250A breaker on the "ON" position.
3. Put inverter breaker in the "ON" position.
4. Push the power button on the front of the unit for 8+ seconds to turn on the LCD display.



**If you install multiple inverters with one or more eVault 18.5, please turn the first inverter on by following the abovementioned steps, then power up the remaining inverters.**

#### 4.4.6 Parallel Connection

Fortress Lithium Batteries with the same capacity may be connected in parallel for up to 12 units only. All wires should be an appropriate gauge and constructed to handle the loads that will be placed upon it. Heavy gauge, high strand copper wire is the industry standard due to its stability, efficiency and overall quality. A qualified installer should understand this and must adhere to the industry standard and published electrical guidelines.



**CAUTION! Fortress Lithium Batteries are designed for parallel operation only - do not arrange in series for increased voltage. Series arrangement can result in damage to Fortress Lithium Batteries and will void warranty!**

The Storage Capacity and total available Amperage are increased by the parallel arrangement. The following illustration shows how to connect multiple batteries in parallel. Please note the overall Voltage is not changed. The available Amperage from the system has been doubled.

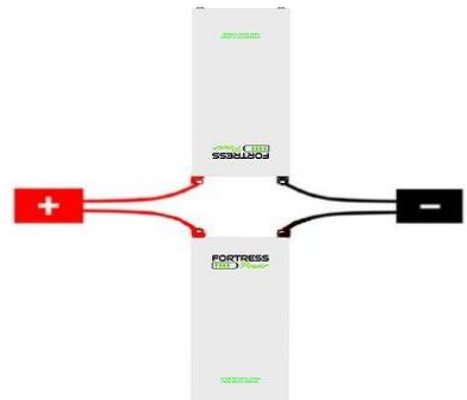

Parallel wiring



**CAUTION! For parallel connecting: Maintain identical wire length and wire construction from each Fortress Power Battery terminal to the common bus. If you parallel more than 4 units, a battery combiner is highly recommended.**

## Please follow the procedure to parallel eVault batteries

- 1. Prepare communication cable.** Each unit comes with one RJ45 cable. If the cable is missing, please make sure the cable you purchase on the market meets the following standards. Please note that a standard RS485 cable is used.

P1	wire color		P2	wire color
P1-1	Orange white	CANH1	P2-1	Orange white
P1-2	Orange	CANL1	P2-2	orange
P1-3	Green white	RS485_A	P2-3	Green white
P1-4	Blue	NC	P2-4	Blue
P1-5	Blue white	RS485_B	P2-5	Blue white
P1-6	Green	ISOGND	P2-6	Green
P1-7	Brown White	RX	P2-7	Brown white
P1-8	Brown	TX	P2-8	Brown

- 2. Use the RJ45 cables to connect the batteries, as illustrated in the chart below.** Use the RJ45 cables to connect the batteries, as illustrated in the chart below. Please always start the chain at the first unit's "RS485" port and Connect to next unit's "CAN" port.

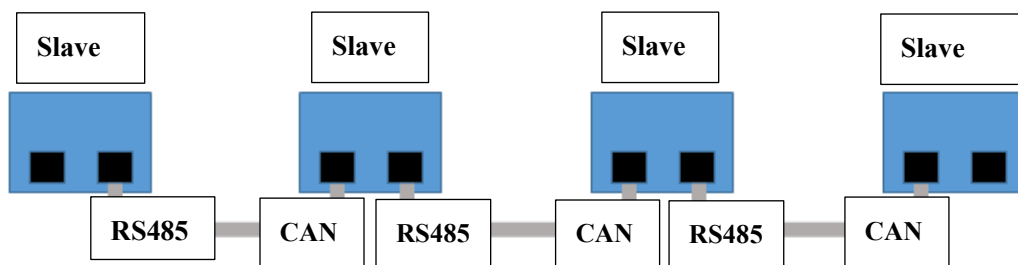

- 3. Check all Battery voltages.** Please make sure the voltage difference between the highest voltage and lowest voltage is less than **0.5 volts**. The batteries will not be connected to the system if the voltage difference is over 0.5 volts. If the voltage gap is greater than 0.5V, please charge the individual batterie(s) with low voltage first.
- 4. Set each battery to "slave" through the touch screen before you start to wire the battery cables.** Click "M-Set" and set each individual battery to "Slave". As next set up the Parallel Number based on how many batteries you connect in parallel. For example, if you parallel 3 batteries in total, please set the Parallel Num of ALL UNITS to "3".

5. Reset all batteries by pushing the power button “OFF” then “ON”, while the battery air breaker is in the “OFF” position.
6. Place bus terminator to match impedance at the LAST unit’s empty CAN port.
7. Wire the battery cables and connect them to positive and negative common bus respectively as described in the previous page.



**CAUTION!** For parallel connecting: Maintain identical wire lengths and wire construction from each Fortress Power Battery terminal to the common bus. \



**CAUTION!** For connecting multiple units: Maintain the recommended distance among units - **at least 5inches (12mm)**.

8. Connect the positive and negative common bus to the inverter. \
9. Set up the FIRST unit as “Master” battery via Touch Screen as described below. Click “M-Set” on the touch Screen, set the first battery as “Master”. Now you should hear the relays clicking and connecting the batteries.

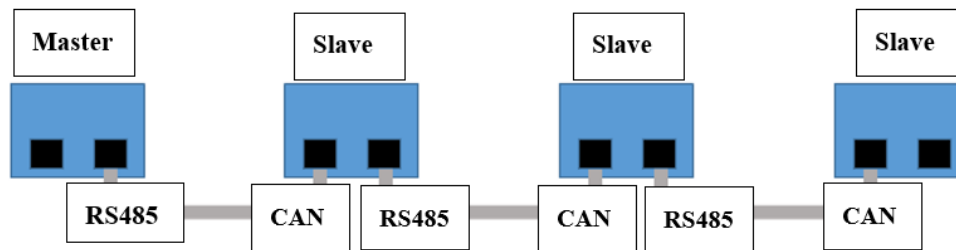

10. Please put battery breaker into “ON” Position

11. Please put inverter breaker into “ON” Position



**CAUTION!** Paralleling the eVault 18.5 batteries without connecting them via RJ45 cable(s), please make sure the difference between the highest voltage and lowest voltage does not exceed 0.5 volts. A large current flow from the higher voltage battery to the lower voltage battery could potentially damage one or both batteries. Resulting damage to the battery will void the warranty.



**CAUTION!** Verify polarity at all connections with a standard voltmeter before energizing the system. Reverse polarity at the battery terminals will void the Warranty and destroy the batteries. Do not short circuit the batteries.

## 4.6 LCD Screen and Alarm Warning

The LCD display on the front of eVault provides Battery Voltage (V), Charging and Discharging Current (A), State of Charge (SOC), as well as Charging and Discharging Power Output (KW). Please note, when the battery is charging, the Current (A) will show negative value; while during the discharging the Current (A) is positive.

The green light (RUN) indicates system is running properly.

The red alarm light (ALARM) will turn on, if the battery experiences one of those scenarios: High voltage (HV); Low voltage (LV); HT (High Temperature); LT (Low Temperature); Open Circuit (OC) and Short Circuit (SC).

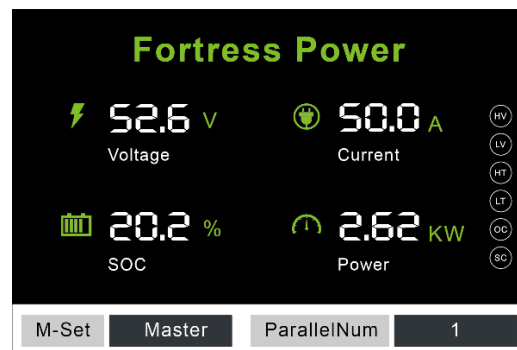

### KEY POINTS SUMMARY:

1. Each Fortress Lithium Battery contains circuitry that protects the Lithium Ferro Phosphate cells from overcharging, over-discharging, and excessive load amperage. If the values specified are exceeded, the battery will enter a protective shut down state. In some cases, this may result in the need to re-initialize an inverter charger or other pieces of equipment in the installation. In other cases, the inverter's system settings may be saved within the inverter memory storage and will not need to be reset. This is not an absolute standard but is common among most inverter chargers. Check your inverter manufacturer specifications.
2. If the battery enters a self-protective mode, negligible voltage readings will be present until the unit is reset. In some instances, after a prolonged shut down, a charge might need to be manually applied to the energy storage bank. Should this occur, please contact Fortress Power for technical support. Fortress Lithium Batteries are designed to remain robust and safe under most circumstances.
3. Although each Fortress Lithium Battery contains circuitry that protects the Lithium Ferro Phosphate cells from overcharging, over-discharging and excessive load amperage, Fortress Lithium Batteries must always be installed with a charge controller and the appropriate settings to protect the batteries from open PV and other high voltage sources. Fortress Lithium Batteries alone will not protect from extreme electrical phenomena.
4. GRID TIED SYSTEMS: Once the Fortress Lithium Battery has been installed, turn on the entire system to test. Once testing has been completed, please disconnect the batteries from the load center until your local Utility Inspector is ready to turn on the entire system. The charge controllers and inverter monitoring systems can drain the Fortress Lithium Batteries over an extended period when the entire system is not fully operational due to the electrical draw of the system components.
5. OFF GRID SYSTEMS: Do not connect the Fortress Lithium Batteries until the entire system is ready to turn on and is fully operational.
6. See Charge Controller Settings in the Appendix of this manual. Fortress Lithium Batteries are compatible with almost all Inverter Chargers and Charge Controllers. Please contact Fortress Power to learn the recommended settings for any device not explicitly covered in this manual.

## 4.7 Final Connection of the Installation

Final installation and operation guidelines will be dictated by your Electrician and Installer based on the overall properties of and procedures for the equipment in your installation and any code requirements that apply to your region. Fortress Power technicians and sales staff are available to provide any additional information on the Fortress Lithium Batteries as needed. Please be aware of the potential electrical hazards before interacting with any and all electrical or mechanical devices. Please take all necessary safety precautions in your projects and installations.

## 4.8 Turn off the Unit

If you need to turn off the unit, please push the button for 8 seconds.

## 5 RETROFITTING

Retrofit Fortress Lithium batteries to an existing system is not recommended. Like all other batteries, Fortress Lithium Battery's open voltage will diminish during the operation. Parallel batteries with different open voltage may cause reverse currents, which could damage the batteries.

## 6 OPERATING

### 6.1 Operating Environment

See "3.1 Technical Data" Table on page 5

### 6.2 Charging

Never attempt to charge a battery without first reviewing and understanding the instructions for the charger being used. Only use a Fortress Power Approved Lithium Ferro Phosphate (LFP) charger if ancillary charging is required before installation, testing or troubleshooting. Failure to use a Fortress Power approved LFP charger will damage the battery and void the warranty



**CAUTION! Do not attempt to charge the battery below 32 degrees F (0 degrees C). Attempts to charge at subfreezing temperatures can adversely affect State of Health (SOC) and cycle life and will void the warranty; never charge battery if it is frozen; never charge a visibly damaged battery.**

#### 6.2.1 Please follow the following steps to use the charger to charge the battery:

1. Connect the charger leads to the battery.
2. Make sure that the charger lead, both at the charger and the battery side, connections are tight.
3. Turn the charger on.



**CAUTION! Recommended charging current is 80A, Max. 170A (Please follow the specification on Fortress Lithium Battery Datasheet.)**

### 6.3 Discharging

- ✓ Do not discharge battery below operating voltage.
- ✓ Do not discharge battery at rates greater than maximum continuous current.
- ✓ Do not operate in conditions that will exceed the internal operating temperatures of the battery.

### 6.4 Parameter set up guide in Charger/Inverter

Before commissioning the energy storage system, the appropriate controller and inverter settings must be programmed per the manufacturer's recommendations. Consult the manufacturer's manuals and/or access technical support (Darfon, Schneider, Outback, SMA, Sol-Ark, Magnum, Outback).

Although Fortress Lithium batteries can perform at very high rates and depths of discharge within a very wide temperature range, in order to achieve extended life cycles and to comply with the Warranty, the following guidelines should be followed:

#### Understand Charge Stage

1. Bulk Charge: Charge at Constant Current (CC) to Bulk/Absorb Voltage
2. Absorption Charge: Maintain Constant Bulk/Absorb Voltage (CV)
3. Terminate when charge current drops below 0.05C
4. Unlike Lead Acid batteries, Lithium Ferro Phosphate batteries do not require Float Charge

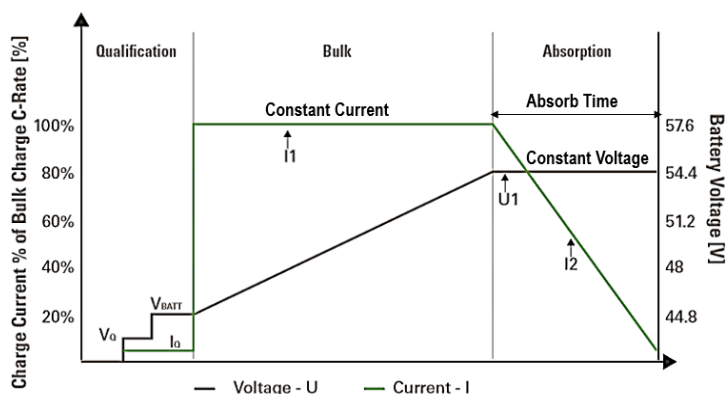

#### Charger/Inverter configuration recommendation for best Performance:

The Battery Parameter Setting Guides with SMA, Sol-Ark, Schneider and Outback Inverters/Chargers are available to download on [www.fortresspower.com/Resource](http://www.fortresspower.com/Resource)

Recommended operating parameters of charger/Inverters For 3,000 Cycles:

- Operating temperature range: 32 F to 120 F (0 °C to 49°C)

Recommended operating parameters of charger/Inverters For 6,000 Cycles:

- Operating temperature range: 50 F to 110 F (10°C to 43°C)
- Storage must be equal to or more than twice the rated output of the Inverter

At the End of Cycle Life capacity is Equivalent to 70% Retained Capacity



**CAUTION! Do Not Operate Fortress Lithium Batteries at an average temperature exceeding 30 °C / 86 °F over the life of the battery.**



## 7. DIAGNOSTIC GUIDE

The smart eVault BMS provides multiple level protection function:

- ✓ Over Charge Voltage Protection
- ✓ Over Discharge Protection
- ✓ Over Current Protection for Discharge Via Thermal Control
- ✓ Short Circuit Protection
- ✓ ON/OFF Switch
- ✓ In the event of a fault the battery protection circuit will open its internal relays disconnecting the negative battery terminals from the internal cells. The battery uses relays and precautions should be taken to reduce voltage spikes and large inductance in the application.

Over Voltage Fault	59.2±0.4V
Over Voltage Recovery	56.8±0.4V
Low Voltage Fault	43.2±0.4V
Low Voltage Recovery	44.8±0.4V

When an Incident occurs or an alarm light is on, please follow this guide as the initial step in the troubleshooting process.







1. Please isolate the battery:
  - a. Turn OFF main Air Breaker on top of the battery
  - b. Remove all external power sources to/from battery
2. Make sure Battery Voltage is consistent with LCD Display:
  - a. Turn ON main Air Breaker on top of the battery
  - b. Use an available Multimeter to measure the voltage at top of the terminals
    - i. If consistent with LCD Display, please measure the voltage of each battery cell
      - Please see Restart BMS by pushing the POWER Button for at least 10s
      - If Alarm Light persists, see “Measure Cell Voltages Manual” in order to remove the back case of the unit and measure each of its cell voltages
    - ii. If inconsistent, please use the BMS Adapter Cable along with BMS Tool Software
      - Once the BMS Tool Software is running, check what Alarm is currently active
      - Follow “Troubleshooting Manual”
3. If Problem persists, please contact Fortress Power Tech Support
  - a. TechSupport@FortressPower.com
  - b. (267) – 684 – 6509

## 8. TROUBLESHOOTING







### 8.1 General Symptom-Solution Situations















Symptom	Solution
Unit voltage at terminals is extremely low or is bleeding down (steep decline)	Unit's BMS is in Protection Mode. There are two possible solutions. <ol style="list-style-type: none"> <li>1. Use a 48V charger to trickle charge the battery in order activate the BMS</li> <li>2. Use the BMS-to-Computer Adapter Cable in conjunction with the BMS Tool Software on a Windows Computer to forcibly reset the Charge/Discharge Relays. Contact Fortress Power Tech Support.</li> </ol>
Unit can charge/discharge healthily but amperage on LCD Display is not accurate	Check amperage on cable with a Clamp Sensor. If consistent with inverter, but not battery, use the BMS-to-Computer Adapter Cable in conjunction with the BMS Tool on a Windows Computer to check BMS Vitals and diagnose situation. If nothing is seen, BMS Tray may need to be taken out. Inspect Main BMS Module for improper solders or burns. Replace if necessary. Contact Fortress Power Tech Support.
"ALARM" LED Light is on but unit still functions	Check Inverter Settings. Use the BMS-to-Computer Adapter Cable in conjunction with the BMS Tool on a Windows Computer to check BMS Vitals and diagnose situation. Follow the below chart (Section 8.2) for solution
"ALARM" LED Light is on but unit cannot function	Try to turn on unit by holding the Power Button. Use the BMS-to-Computer Adapter Cable in conjunction with the BMS Tool on a Windows Computer to check BMS Vitals and diagnose situation. Follow the below chart for solution. Follow the below chart (Section 8.2) for solution
If cells are imbalanced (upon checking with the BMS Tool)	Open Back case and check harness connections are connected properly. Make sure all connections have "Black" wires on the left side (regardless of orientation) and "Red" on the right side. Check voltages of each cell (See "Measure Cell Voltages Manual")
LCD Display went Dark	LCD Display will automatically go dark after 60 seconds of inactivity to preserve energy consumption. If problem persists, open front case and check LCD Display connections.
Whole system (Inverter and Battery) shut off	Check Breaker to see if tripped. Set Breaker to "Off" then turn back to "On". Reset Battery BMS. Try to restart battery by holding down the Power Button. If problem persists, use the BMS-to-Computer Adapter Cable in conjunction with the BMS Tool on a Windows Computer to check BMS Vitals and diagnose situation.

## 8.2 LCD Display Warnings

Error	Meaning
	over high voltage protection
	over low voltage protection
	Discharge over-temp protection, charge over-temp protection, environmental over-temp protection
	Discharge low-temp protection, charging low-temp protection, environmental low-temp protection
	Discharge over current protection, charge over current protection
	Short circuit protection

## 8.3 Fundamental Troubleshooting Guide

Running state	Status	RUN	ALM	Display	Solution
	Normal	●	-	-	-
Charge	Total overvoltage alarm	●	-		stop charge
	Total overvoltage protection	●	●		stop charge, start discharge
	cell over-voltage alarm	●	-	-	stop charge
	cell over-voltage protection	●	●	-	stop charge
	over current alarm	●	-		lower the power used
	over current protection	●	●		Disconnect the battery and turn it on after lowering the power
Discharge	total low-voltage alarm	●	-		start charging
	total low-voltage protection	●	●		charging activation
	cell low-voltage alarm	●	-	-	start charging
	cell low-voltage protection	●	●	-	charging activation

	over current alarm	●	-		lower the power used
	over current protection	●	●		Disconnect the battery, stop using the battery, and reset BMS once within a safe range
Temperature	charge over-temperature alarm	●	-		reduce the environment temperature, lower the power used
	charge over-temperature protection	●	●		Disconnect the battery, stop using the battery, and reset BMS once within a safe range
	charge low-temperature alarm	●	-		reduce the environment temperature
	charge low-temperature protection	●	●		Disconnect the battery, stop using the battery, and reset BMS once within a safe range
	discharge over-temperature alarm	●	-		reduce the environment temperature
	discharge over-temperature protection	●	●		Disconnect the battery, stop using the battery, and reset BMS once within a safe range
	discharge low-temperature alarm	●	-		improve the environment temperature
	discharge low-temperature protection	●	●		Disconnect the battery, stop using the battery, and reset BMS once within a safe range
	environment over temperature alarm	●	-		reduce the environment temperature
	environment over temperature protection	●	●		reduce the environment temperature
	environment low temperature alarm	●	-		improve the environment temperature
	environment low temperature protection	●	●		improve the environment temperature

## PLEASE CONTACT US FOR TECHNICAL SUPPORT

Fortress Power, LLC  
 505 Keystone Road,  
 Southampton, Pennsylvania, 18966  
 877.497.6937  
[sales@fortresspower.com](mailto:sales@fortresspower.com)  
[www.FortressPower.com](http://www.FortressPower.com)

