

The Solarland® SLB-0112 mounting kit has been specifically design for use with the Solarland® SLP Series 10W – 40W panels. This mount is a fixed, flat or pole mount design giving a tilt angle range of 0° - 90°

Components And Parts

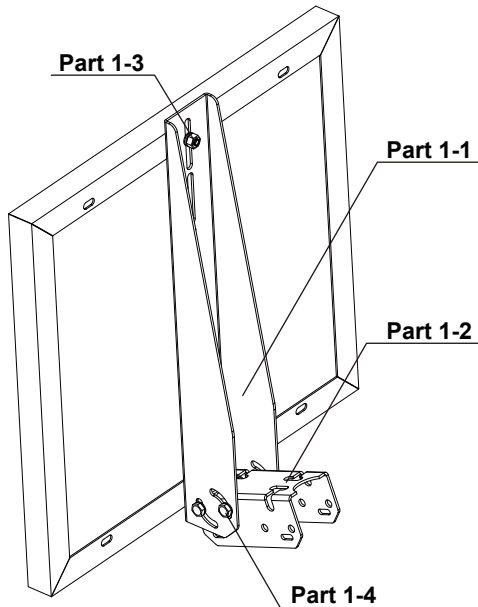

Part

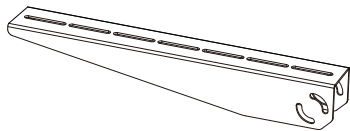

Part 1-1	
Component	Tilt Arm
Material	5052Al
Quantity	1

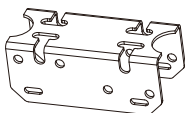

Part 1-2	
Component	Fixed Bracket
Material	5052Al
Quantity	1



Part 1-3-1	
Component	Module Bolt(M8)
Material	AISI304
Quantity	2



Part 1-3-2	
Component	Mounting Bolt(M6x20)
Material	AISI304
Quantity	4



Part 1-4	
Component	Mounting Bolt(M8)
Material	AISI304
Quantity	4

Step1. Assemble the components and parts together according to **figure 1**. We suggest you lubricate all nuts and bolts to facilitate easy removal at a later date.

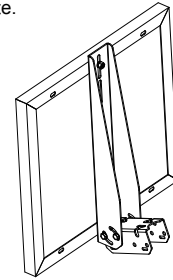

figure 1

Step2. Attach the tilt arm and fixed bracket to the middle part of the PV module frame using M8 module bolts and M8 mounting bolts along with washers, lock washers and nuts.

CAUTION: Additional mounting holes may be required if using this mount with a panel other than the Solarland SLP series. Great care should be taken when drilling additional holes as damage to the panel can easily occur, rendering it useless

Step3.To adjust the tilt angle of the PV panel, change the location of M8 bolts in the arc hole of the tilt arms. Remember to use lock washers to prevent vibration from working them loose.

Step4. For pole mounting, use hose clamps(not included) to fix the PV module and mount assembly securely to the pole. **See figure 2**. The U-Bolts, Steel Clamps and Molly Bolts are not included in the kit

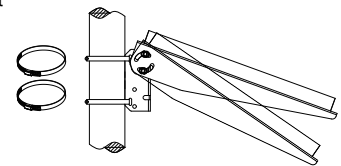

figure 2

Note:

For vertical wall mounting, drill holes on the mounting place to be installed according to size of the fixed bracket. Embed two M8 molly bolts into the mounting surface. **See figure 3**.

Use washers and, lock washers and nuts to secure the PV module and mount assembly to the wall surface.

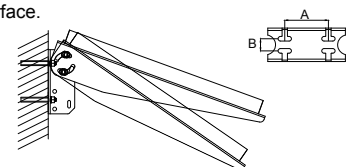

figure 3